

User's Manual for TL-30x Laser Engraving and Cutting Control System

Shenzhen Topwisdom Technology Co., Ltd

Add: 4F, NO.58, East Side of Yousong Road, New Longhua District, ShenZhen, China, 518109

Tel: +86-0755-82057902

Fax: +86-0755-82057892

Website: <http://www.topwisdom.com.cn>

Copyright Statement

Shenzhen Topwisdom Technology Co., Ltd.

All rights reserved.

Shenzhen Topwisdom Technology Co., Ltd. (Topwisdom Technology hereinafter) reserves the rights of final interpretation and modification for this manual and declaration. Topwisdom Technology owns the patents, copyright and other intellectual property rights for its product and software. Without authorization, no one is allowed to copy, excerpt, reproduce, process, disseminate and use this product and its relative parts directly or indirectly.

Disclaimer

Topwisdom Technology reserves the right to modify the content described in this manual without advance notice. Topwisdom Technology is not responsible to any direct, indirect, or consequential damage or liability caused by improper use of this manual or the product. Machinery in motion can be dangerous! It is the responsibility of the user to design effective error handling and safety protection as part of the machinery. Topwisdom Technology shall not be liable or responsible for any incidental or consequential damages.

Technical Support

To get our technical support and after-sale service:

Tel: +86-0755-82057902

Fax: +86-0755-82057892

Website: <http://www.topwisdom.com.cn>

Content

Part 1 Overview	1
1.1 System Overview.....	1
1.2 Notes and Warning.....	1
1.3 Work Environment	2
1.4 Power Supply and Grounding.....	2
1.4.1 Power Supply Requirements	2
1.4.2 Grounding Requirements	2
1.5 Accessory List.....	2
Part 2 Wiring Installation Instruction	5
2.1 Installation Dimension	5
2.2.1 Panel	5
2.1.2 Wiring board Dimension	6
2.2 Wiring Instruction.....	7
2.2.1 Wiring Board.....	7
2.2.2 Wiring Diagram.....	8
2.3 Interface Instruction	11
2.3.1 Power Signal	11
2.3.2 Data Bus Interface.....	12
2.3.3 Flash disk cable interface	13
2.3.4 PC USB cable interface.....	13
2.3.5 Output.....	13
2.3.6 Laser Power Interface	15
2.3.7 Input	17
2.3.8 Input Signal Diagram	19
Part 3 Software Installation	20
3.1 Installing CorelDRAW Direct Output	20

3.1.1 Manual Install	21
3.1.2 Auto Install.....	22
3.2 Uninstalling CorelDRAW Direct Output.....	23
3.3 Installing CAD Direct Output.....	23
3.4 Uninstalling CAD Direct Output	25
3.5 USB Driver Installation	26
3.6 USB Port Setting	29
3.6.1 View the assigned COM Port by Computer	29
3.6.2 Change the Assigned COM port by Computer	32
3.7 IP Setting.....	33
Part 4 Software Operation Guide.....	37
4.1 CorelDRAW Direct Output Software Operation	37
4.1.1 Layer Parameter Setting.....	38
4.1.2 Coordinate Setting.....	42
4.1.3 Track Setting	43
4.1.4 Single Axis Operation	44
4.1.5 Output Engrave	45
4.2 The Equipment Management	49
4.2.1 Toolbar.....	50
4.2.2 Parameter Setting	50
4.2.3 Embroidery Import.....	55
4.2.4 Import Bitmap	56
4.2.5 Curve Precision	57
4.3 CAD Direct Output Software Operation	57
4.4 CAD Direct Output Software Supplementary Description	58
4.4.1 The Support of AutoCAD Direct Output Annotation Text.....	58
4.4.2 Carving Gradient Sketch Map	60
4.4.3 Coordinate System.....	60
4.4.4 Supplementary Description of Carving	61

4.4.5 Supplementary Description of Software and CAD Direct Output	62
Part 5 Panel Operation	66
5.1 Panel and Key Instruction.....	66
5.1.1 Panel	66
5.1.2 Key	66
5.2 Interface Introduction.....	68
5.2.1 Start Up	68
5.2.2 Main Interface.....	69
5.2.3 Menu	71
5.2.4 Value setting.....	72
5.3 File Manage.....	73
5.3.1 Files in Card	74
5.3.2 Flash Disk.....	74
5.3.3 Output File.....	76
5.3.4 File Receiving Setting.....	77
5.3.5 Work Loop	77
5.4 Equipment Type.....	78
5.5 Axis Move	79
Part 6 Assistant function	80
6.1 Normal Parameter	80
6.1.1 Key Set.....	81
6.1.2 Laser Set.....	82
6.1.3 Return Point	83
6.1.4 Other Set.....	84
6.1.5 Cover Set	84
6.1.6 Light Delay	85
6.1.7 Time Set	85
6.1.8 Equipment Number	86
6.1.9 Password Set	86



6.1.10 Unlock Machine Password Preview	87
6.1.11 Language.....	87
6.1.12 Laser Time.....	88
6.1.13 Uptime.....	88
6.1.14 Work Time	89
6.1.15 Process Times.....	89
6.1.16 X Travel	89
6.1.17 Y Travel	90
6.2 Axis Parameter Setting	90
6.2.1 Axis Parameter	91
6.2.2 Resolution	91
6.2.3 Other Axis Parameters Setting	92
6.3 Back Set.....	93
6.4 System Setting	93
Part 7 The Frequently Asked Question Help.....	95
7.1 Power-on Reset Question	95
7.2 The Laser Light Question	96
7.3 The PC Connection Question.....	96
7.4 The Reading and Writing of U disk Question.....	97

Part 1 Overview

1.1 System Overview

Thank you very much for using laser engraving control system of our company!

This system can be used with various types of laser engraving cutting machine, meets your different requirements for processing.

- Use High-Performance 32-Bit CPU with Single-Precision Floating-Point Unit (FPU), the main frequency is up to 150MH. Setting device parameter out of PC completely. All coupler completely isolated from outside interference, the system is reliable.
- Support USB2.0 port, U disk reading and writing, support U disk system upgrade;
- With 64MB storage, work independently form PC, which is useful for the quantities of engraving and cutting production.
- Support 4 axes motion control(X Y Z U, XY is for laser cutting control, Z is feeding axis, U is lift axis).
- Support feeding, lifting, rotating engraving, metal cutting, scale cutting, automatic blowing, automatic focusing, foot switch, cover protect, power-off cutting restoration, system lock, device management.
- S-shape acceleration and deceleration and adjustable velocity profile, meet the demand of smooth cutting and high speed working.

Before using, please read our manual carefully, ensure to operate our system correctly.

Please keep the manual well, and it's convenient for your future references.

Because of different configuration, some devices have not some of the functions listed in the manual, the details subject to appropriate operation functions.

1.2 Notes and Warning

- Prohibit the non-professionals to maintenance and debug the electrical system, if not, this will reduce device's safety performance, and expand failure, even cause accident and property loss.
- Please do not piles up debris on the control box, and in the course of using,

regularly remove the dust of the control box surface and filters, to keep good ventilation.

- When users have to open the cover of the control box, must cut off the power after 5minutes and under the professionals' guidance, only can be allowed to touch the components in the electrical control box!
- Prohibit touching any motion parts or opening the control equipments when the machine is working, or it maybe bring about the accident and machine can't work.
- Prohibit using the electrical equipment in the damp, dust, corrosive gas, flammable gas area, or it maybe cause the electrical shock or fire!

1.3 Work Environment

- Ventilation, sanitation, and less dust
- Storage temperature: 0-50°C
- Work temperature: 5-40°C
- Work relative humidity: 30%-90%(no condensation)

1.4 Power Supply and Grounding

1.4.1 Power Supply Requirements

- Core power supply: DC 5V, 3A; External power supply: DC 5V, 3A
- According to different machine configurations, power consumption is between 0.1-0.2KW



1.4.2 Grounding Requirements

- In order to prevent electrical equipment due to leakage, over-voltage, insulation etc causes of the electrical shock or fire, please make the electrical control reliable grounding.

Grounding resistance is less than 100 ohms; the length of wire cable is within the 20meters, the cross-sectional area of the wire cable is larger than 1.0 mm².

1.5 Accessory List

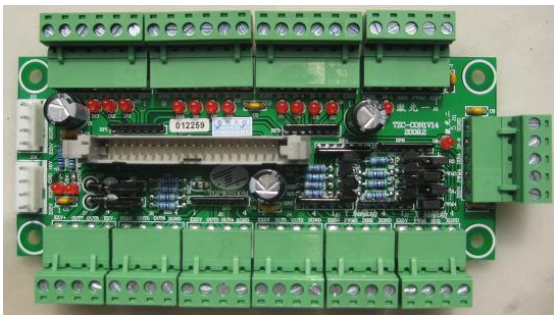
The Laser Engraving Control System TL-30X contained the accessories as below:

Name	Qty	Introduction	Photo
Operation Panel	1	For user operation	
TZC-CONV 14	1	Wiring board	
Connection cable	1	USB communication cable for connecting controller and PC	



Power cable	1	Power supply cable	
-------------	---	--------------------	--

Part 2 Wiring Installation Instruction

2.1 Installation Dimension

2.2.1 Panel

The installation dimension of operation panel (the unit is MM):

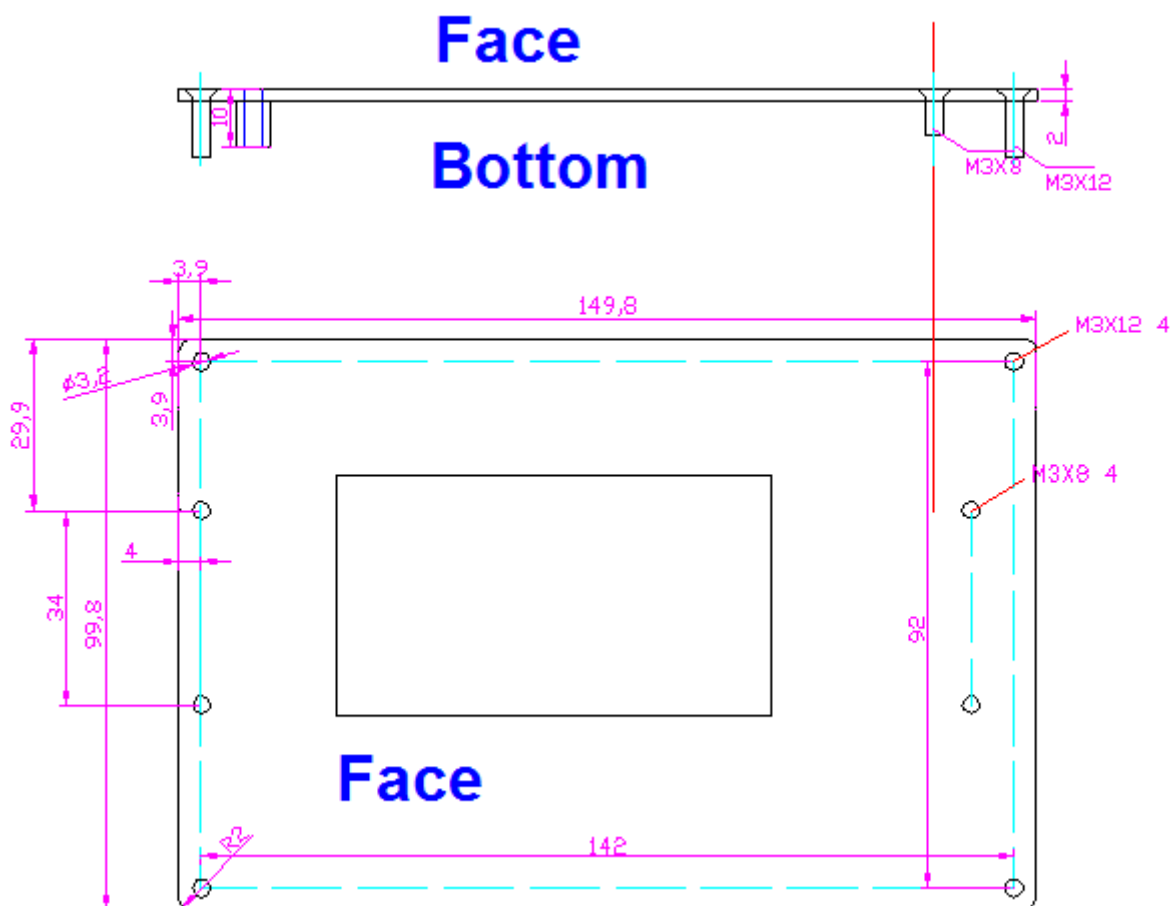

Fig. 2-1

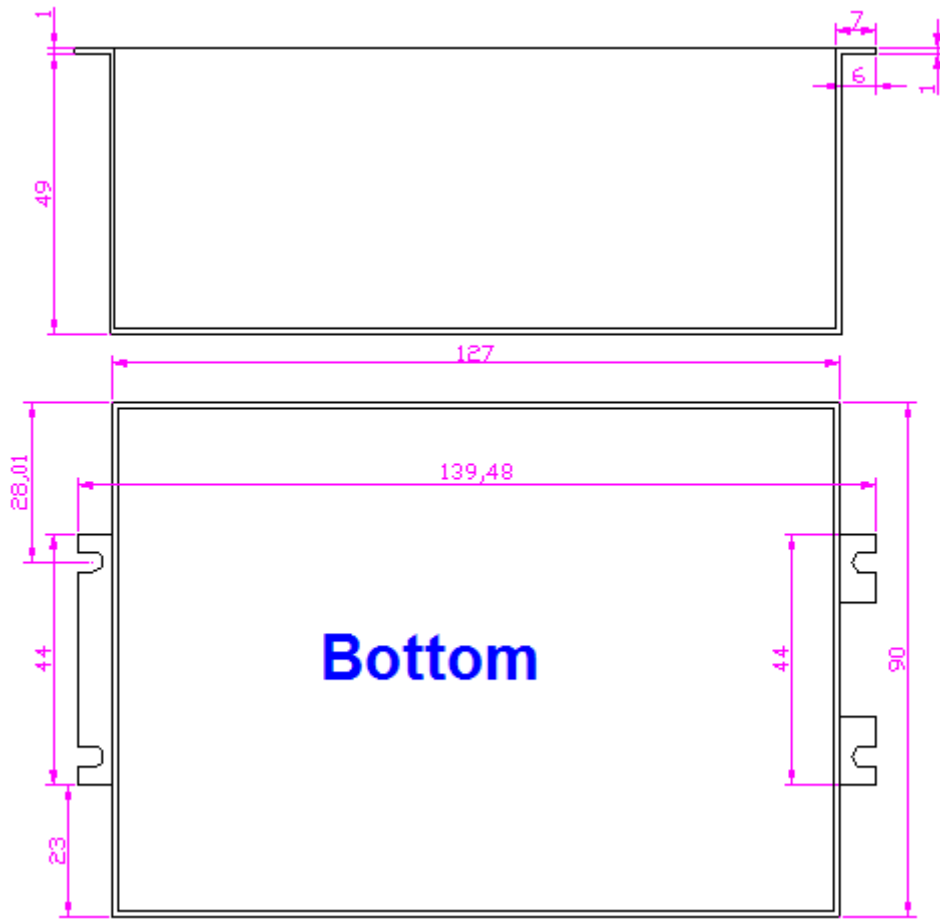

Fig. 2-2

2.1.2 Wiring board Dimension

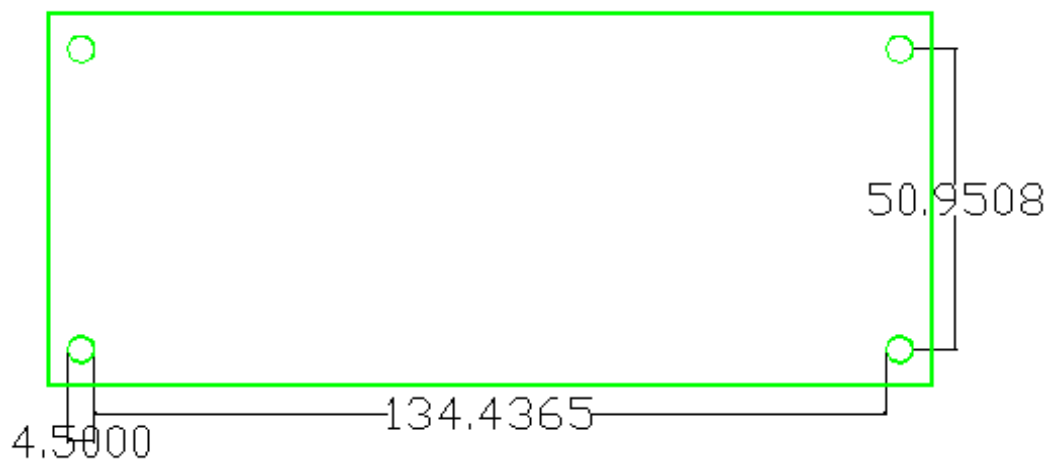

Fig. 2-3

2.2 Wiring Instruction

2.2.1 Wiring Board

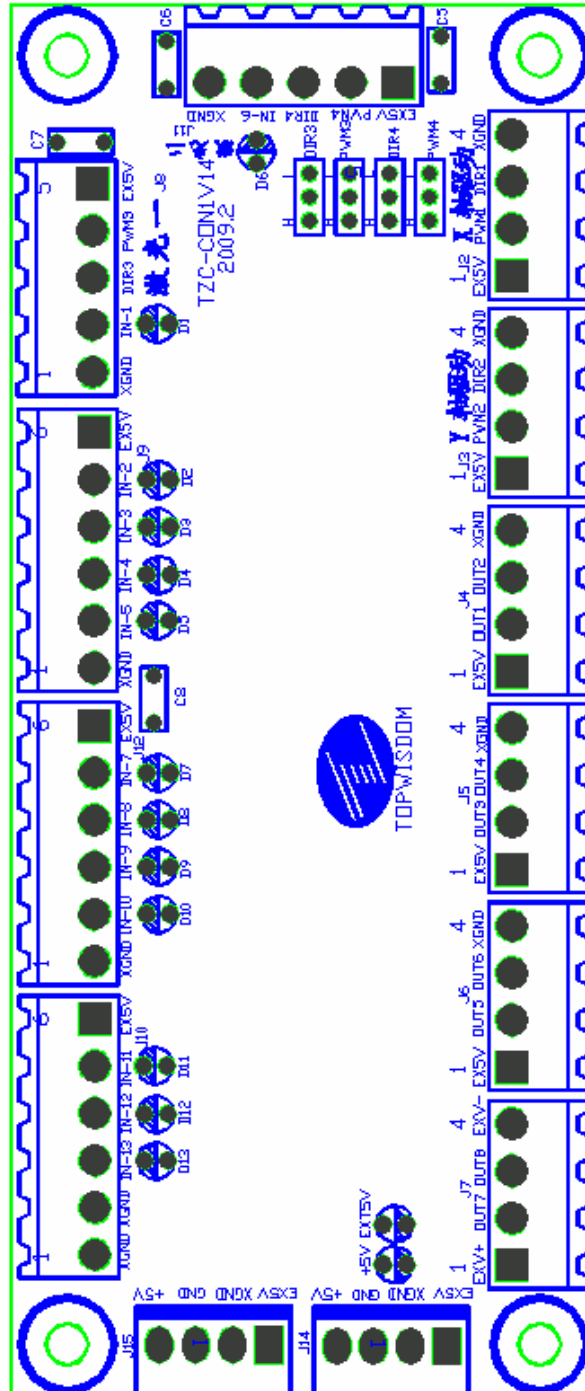

Fig. 2-4

2.2.2 Wiring Diagram

2.2.2.1 Motor Wiring

The following is X axis motor wiring, other axis are similar.

1. Step Motor Wiring

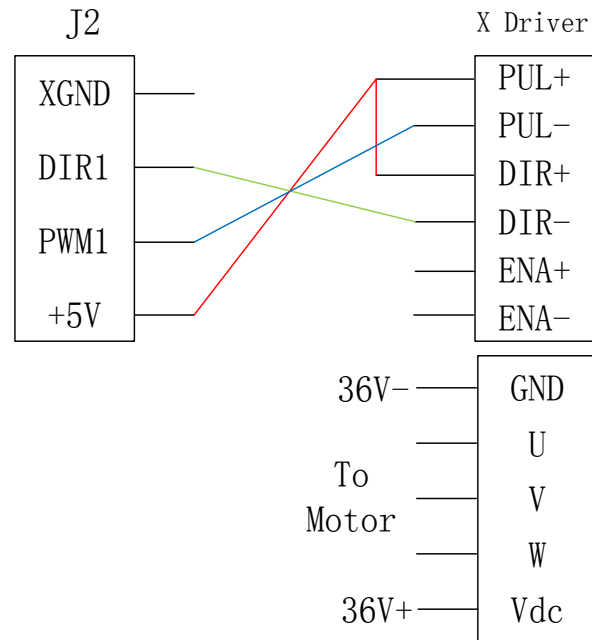

Fig. 2-5

2. Panasonic Servo Wiring

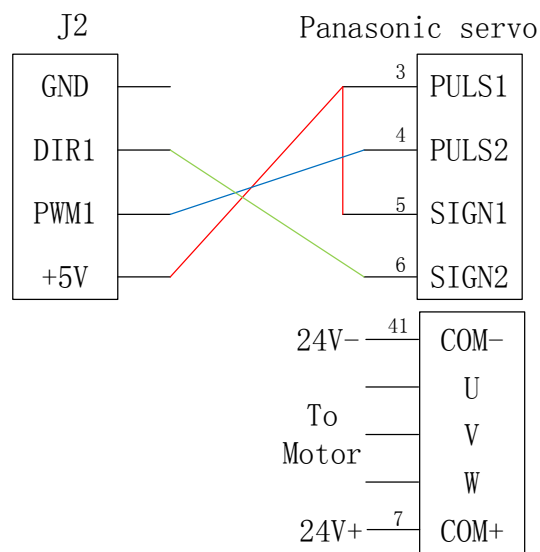

Fig. 2-6

2.2.2.2 Laser Power Supply Wiring

1. CO2 Laser Power Supply Wiring

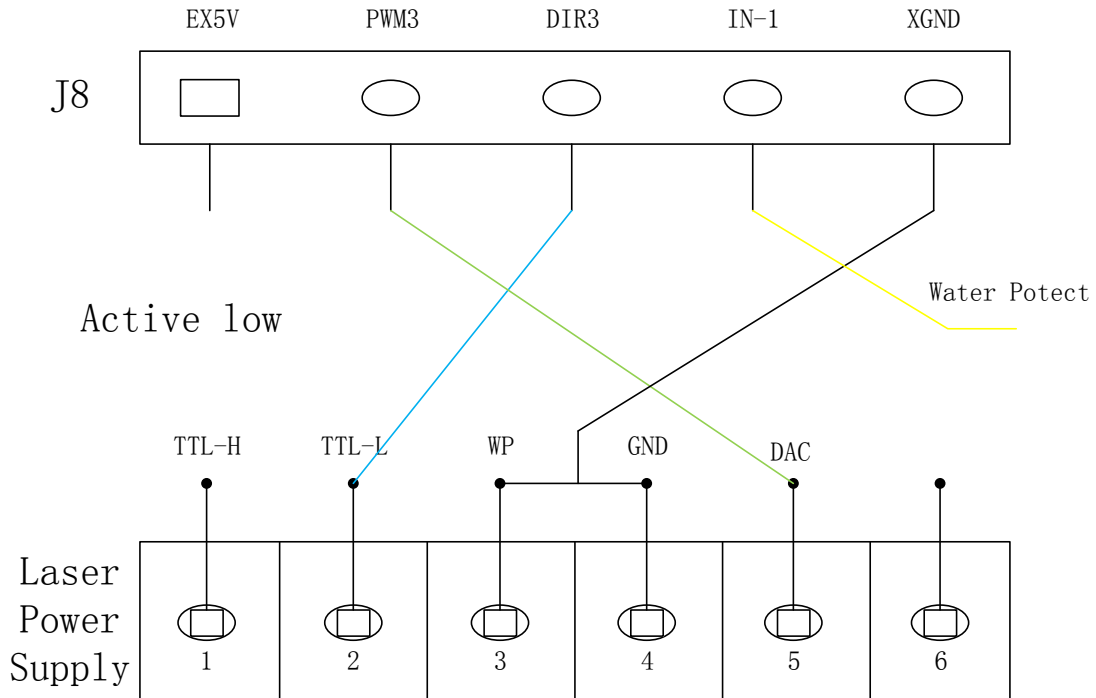

Fig. 2-7

2.RF Laser Wiring

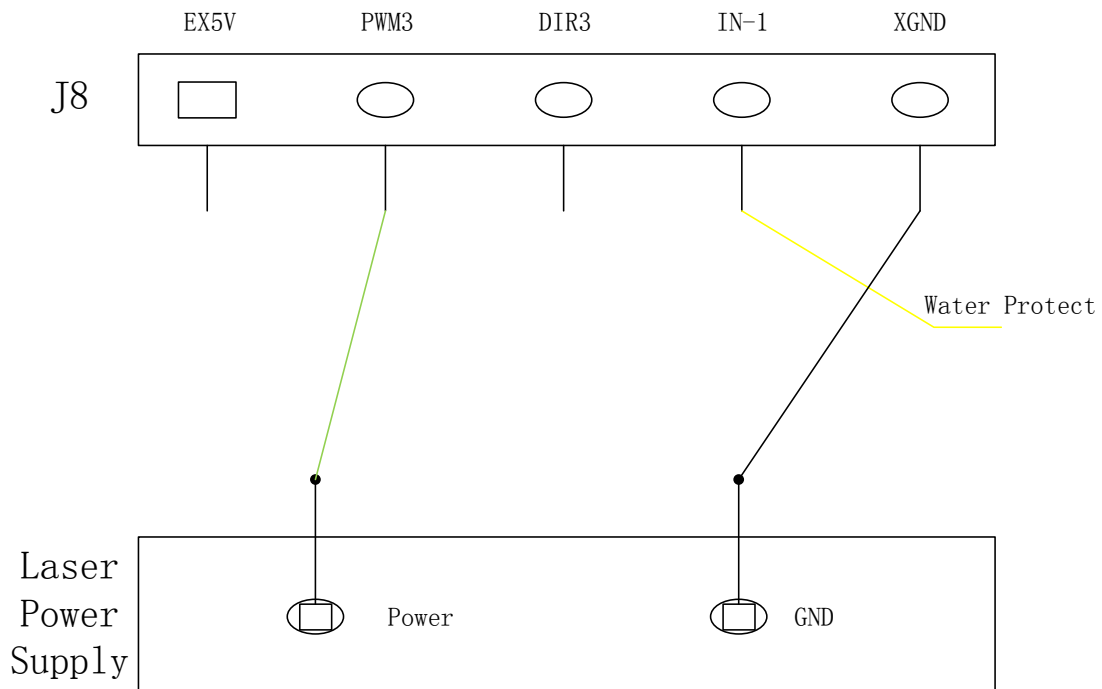

Fig. 2-8

The wiring of laser 2 is similar.

Note: When “RF1 or RF2” is selected, please set the PWM Frequency according to the data sheet of the laser. Generally, PWM Frequency is 5000Hz. And set the Laser Max parameter not larger than 95%, especially not to set as 100%, otherwise it works improperly.

2.2.2.3 Blowing Air Signal Wiring

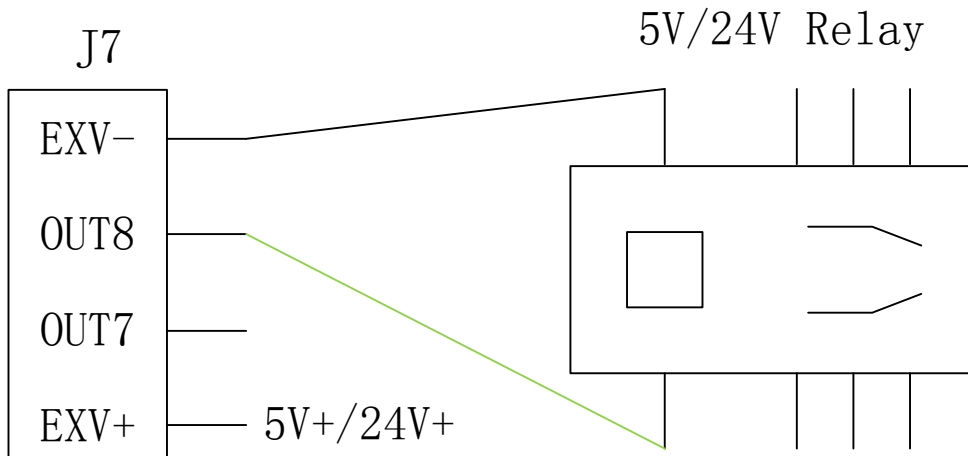

Fig. 2-9

2.2.2.4 Pen UP/Down Signal Wiring

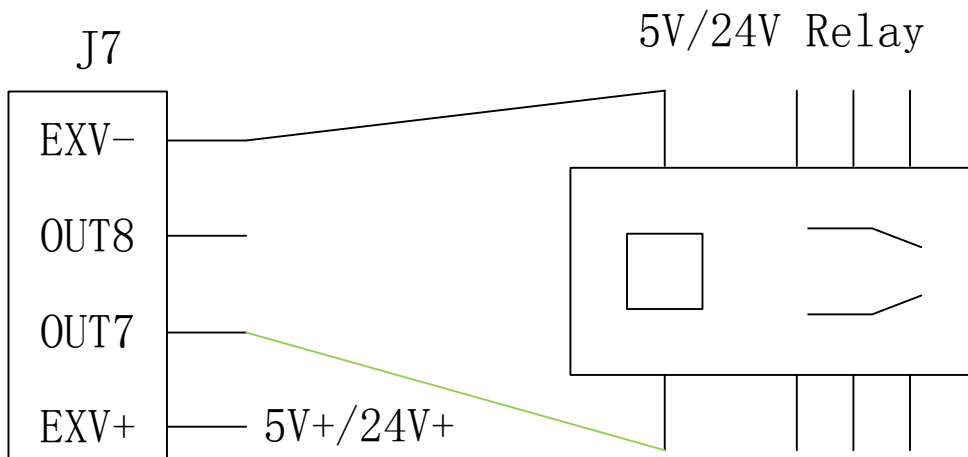

Fig. 2-10

2.2.2.5 Limit Switch Signal Wiring

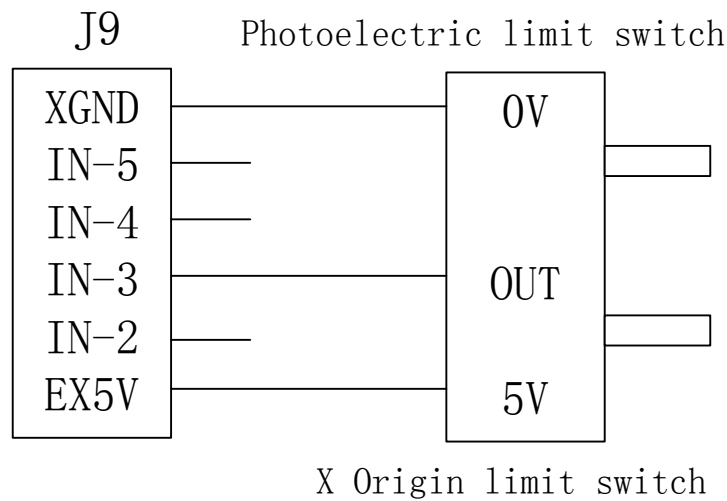

Fig. 2-11

Other limit switch wirings are similar.

2.3 Interface Instruction

2.3.1 Power Signal

The system is dual 5V power supply

The 5V power interface J15 (switching power interface)

Pin	Define
1	EX5V External 5V power source positive (input)
2	XGND External 5V power source grounding (input)
3	GND Internal 5V power source positive (input)
4	+5V Internal 5V power source grounding (input)

The power interface J14 (for Panel)

Pin	Define
1	EX 5V External 5V power source positive (output)
2	XGND External 5V power source grounding (output)
3	GND Internal 5V power source positive (output)
4	+5V Internal 5V power source positive (output)

2.3.2 Data Bus Interface

Data Bus Interface J1

Pin	Define
1	E5VG
2	OUT4
3	OUT3
4	OUT2
5	OUT1
6	E5VG
7	DIR4
8	PWM4
9	DIR3
10	PWM3
11	E5VG
12	DIR2
13	PWM2
14	DIR1
15	PWM1
16	E5VG
17	OUT5
18	OUT6
19	OUT7
20	OUT8
21	E5VG
22	INPUT12
23	INPUT11
24	INPUT10

25	INPUT9
26	INPUT8
27	INPUT7
28	INPUT6
29	INPUT5
30	INPUT4
31	INPUT3
32	INPUT2
33	INPUT1
34	E5VG
35	INPUT16
36	INPUT15
37	INPUT14
38	INPUT13
39	EXT5V
40	EXT5V

2.3.3 Flash disk cable interface

Main board interface J9, labeled flash disk connecting cable. Flash disk can be inserted directly.

2.3.4 PC USB cable interface

Main board interface J8, labeled PC connecting cable. Connect the computer with USB connecting cable to read and write the file.

2.3.5 Output

1.Drive interface

X axis interface J2

Pin	Define
1	EX5V OUT 5V PUL+、 DIR+(output)
2	PWM1 Stepping pulse (output) PUL-
3	DIR1 Direction signal (output) DIR-
4	XGND OUT 5V GND (output)

Y axis interface J3

Pin	Define
1	EX5V OUT 5V P+ (output) PUL+、 DIR+
2	PWM2 Stepping pulse (output) PUL-
3	DIR2 Direction signal (output) DIR-
4	XGND OUT 5V GND (output)

Z axis interface J4

Pin	Define
1	EX5V OUT 5V P+ (output) PUL+、 DIR+
2	OUT1 Stepping pulse (output) PUL-
3	OUT2 Direction signal (output)DIR-
4	XGND OUT 5V GND (output)

U axis interface J5

Pin	Define
1	EX5V OUT 5V P+ (output) PUL+、 DIR+
2	OUT3 Stepping pulse (output) PUL-
3	OUT4 Direction signal (output)DIR-
4	XGND OUT 5V GND (output)

2. General output interface

General IO output interface J6 (Expansion port)

Pin	Define
1	EX5V External 5V power source positive (output)
2	OUT5 Reserved
3	OUT6 Reserved
4	XGND External 5V power source grounding (output)

3. Relay control signal interface J7

Pin	Define
1	EXV+ Connect to pin 1 of J16 or external 5V/24V power source
2	OUT7 In the brush mode, lifting signal, high effective, connect to the relay coil "+" side
3	OUT8 Blow air signal, high effective, connect to the relay coil "+" side
4	EXV- Connect to the relay coil "-" side

The input voltage of relay has many kinds, such as 5V, 12V, 24V, but the 5V is the best.

2.3.6 Laser Power Interface

The interface of laser power 1 J8

Pin	Define
1	EX5V External 5V power source positive (output)
2	PWM3 Be used to control the laser When the laser is RF laser, used to control the power intensity and light of the laser. When the laser is domestic glass tube, used to control the electric current.
3	DIR3 Laser enable control (DIR3 jumper to H, the signal is high and effective, to L, the signal is low and effective.)



	When the laser is RF laser, used to control the enable function of laser. When the laser is domestic glass tube, used to control laser On/Off.
4	IN—1 Laser status, the corresponding instruction is LED D1 When the laser is RF laser, used to the state input of laser. When the laser is domestic glass tube, used to the state input of water conservation (active low).
5	XGND External 5V power source grounding(output)

The interface of laser power 2 J11

Pin	Define
1	EX5V External 5V power source positive (output)
2	PWM4 Be used to control the laser When the laser is RF laser, used to control the power intensity and light of the laser. When the laser is domestic glass tube, used to control the electric current.
3	DIR4 Laser enable control (DIR4 jumper to H, the signal is high and effective, to L, the signal is low and effective.) When the laser is RF laser, used to control the enable function of laser. When the laser is domestic glass tube, used to control laser On/Off.
4	IN—6 Laser status, the corresponding instruction is LED D6 When the laser is RF laser, used to the state input of laser. When the laser is domestic glass tube, used to the state input of water conservation (active low).
5	XGND External 5V power source grounding(output)

2.3.7 Input

1. The limit interface

X, Y axis limit interface J9

Pin	Define
1	EX5V External 5V power source positive (output)
2	IN—2 X upper limit, axis movement to the max coordinate limit sensor input
3	IN—3 X origin limit, axis movement to the minimum coordinate (0) limit sensor input
4	IN—4 Y upper limit, axis movement to the max coordinate limit sensor input
5	IN—5 Y origin limit, axis movement to the minimum coordinate (0) limit sensor input
6	XGND External 5V power source grounding (output)

Z, U axis limit interface J12

Pin	Define
1	EX5V External 5V power source positive (output)
2	IN—7 Z origin limit, axis movement to the minimum coordinate (0) limit sensor input
3	IN—8 U origin limit, axis movement to the minimum coordinate (0) limit sensor input
4	IN—9 Opening protection signal input
5	IN—10 Foot switch signal input
6	XGND External 5V power source grounding (output)

2. The general input interface

Input interface J10

Pin	Define
1	EX5V External 5V power source positive (output)

2	IN—11	U axis upper limit switch input
3	IN—12	U axis lower limit switch input
4	IN—13	Input
5	XGND	External 5V power source grounding (output)
6	XGND	External 5V power source grounding (output)

Input interface J J13

Pin	Define
1	EX5V External 5V power source positive (output))
2	IN—14 Input
3	IN—15 Input
4	IN—16 Input
5	XGND External 5V power source grounding (output)
6	XGND External 5V power source grounding (output)

* When using the single laser control, the water protection signal of another laser must be shorted with XGND, otherwise, the machine don't work.

The connection ways of switch input signal:

- When using approaching switch, the corresponding parameters of upper PC must be set as "Negative" by NPN; the corresponding parameters of upper PC must be set as "Positive" by PNP.
- When using straight or magnetic induction switch, the corresponding parameters of upper PC must be set as "Negative" while receiving signal + XGND; the corresponding parameters of upper PC must be set as "Positive" while receiving signal + EX5V.

2.3.8 Input Signal Diagram

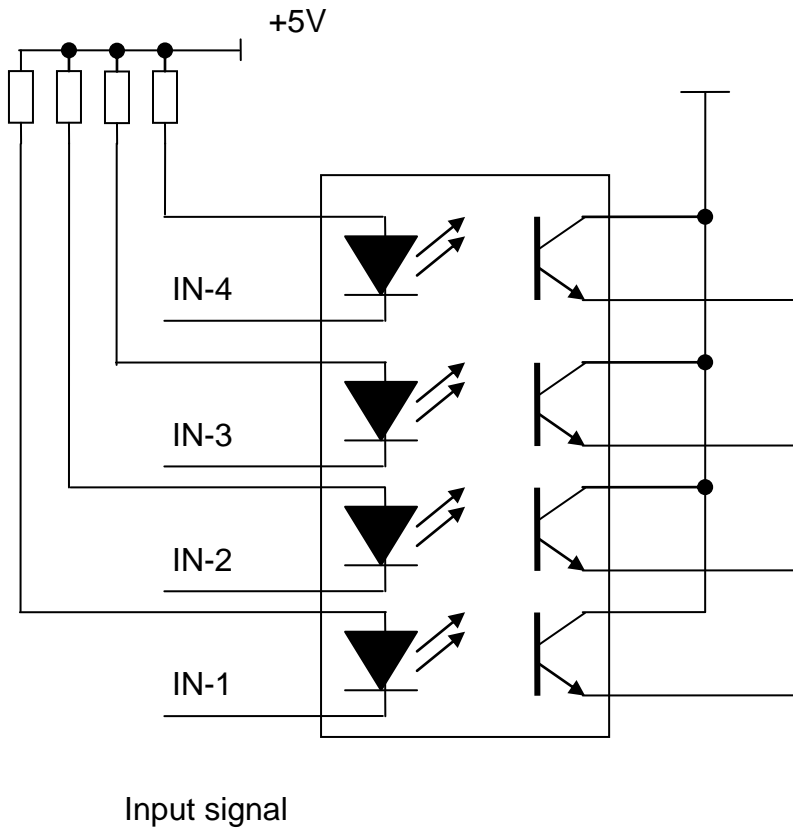



Fig. 2-12

Part 3 Software Installation

3.1 Installing CorelDRAW Direct Output

CorelDRAW12 or a higher version needs to be installed firstly. Then double click the icon  CorelCamera_V8.7.8.exe (below CorelCamera_V8.7.8 is used to introduce), a screen shown in Fig. 3-1 will be displayed for selecting installing language.

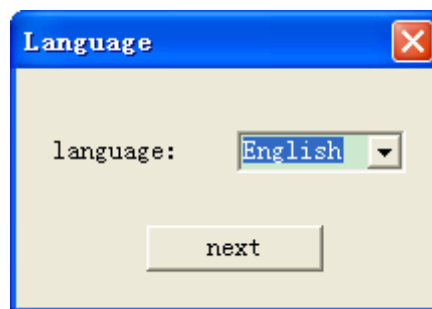

Fig. 3-1

Click "next" to proceed with installation.

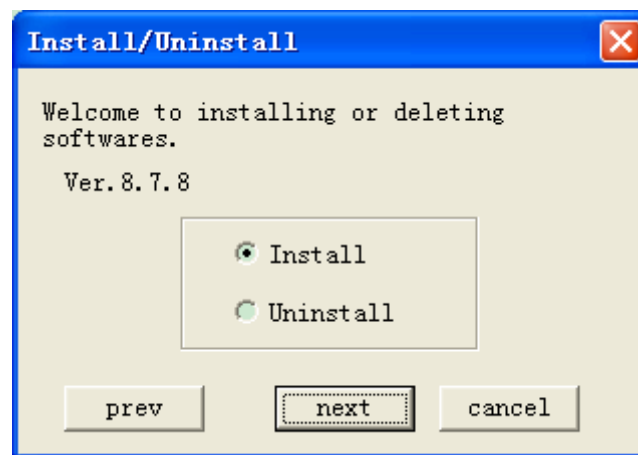

Fig. 3-2

Select "Install" to install software, or select "Uninstall" to uninstall software. Then click next. And the screen shown in Fig. 3-3 is displayed.

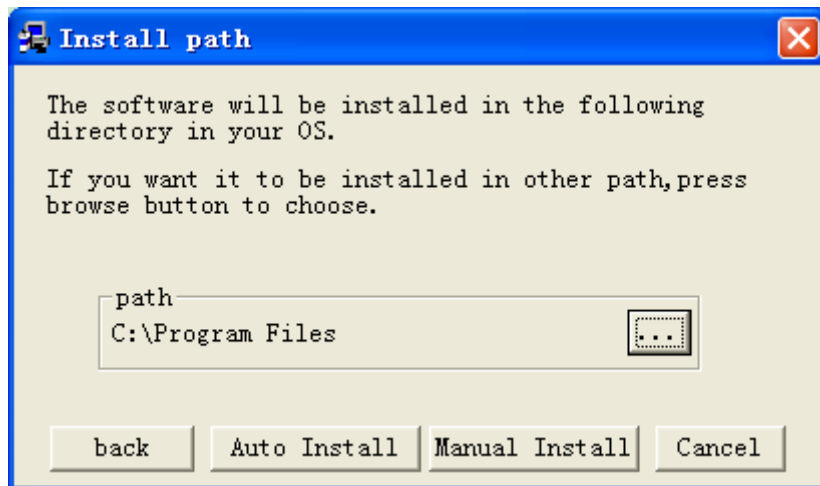

Fig. 3-3

3.1.1 Manual Install

Click the  button to find the CorelDRAW install path, as shown in Fig.3-4, select the Corel Graphics 12 folder as below.

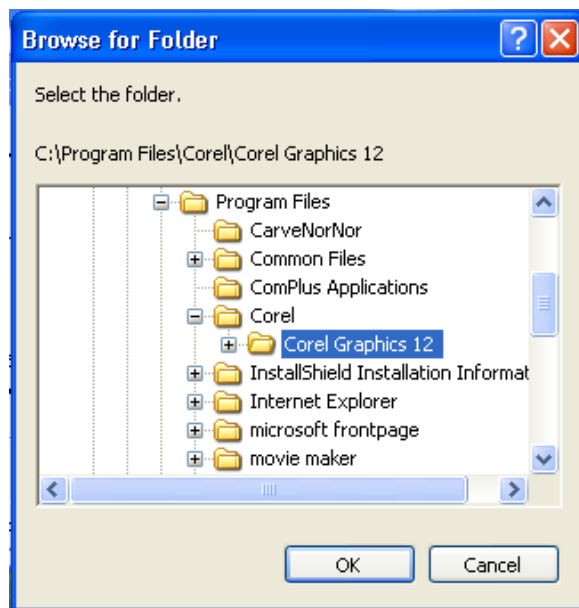

Fig. 3-4

When the installed path is found, click the Confirm to go back to the screen shown in Fig.3-3. Then click the “Manual install” to install. When installation is finished, the screen shown in Fig. 3-5 is displayed. Click “OK” to finish.

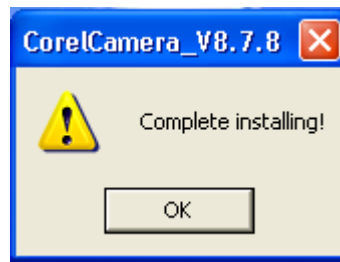

Fig. 3-5

3.1.2 Auto Install

Click the “Auto Install” button shown in Fig. 3-3, the program will find the install path automatically. When installation is finished, the screen shown in Fig. 3-5 is displayed. Click “OK” to finish.

However, the installation is not really completed then, as you need to make configurations for the CorelDRAW software, after the configuration the total installation will be completed, then open CorelDRAW, it'll show as below.

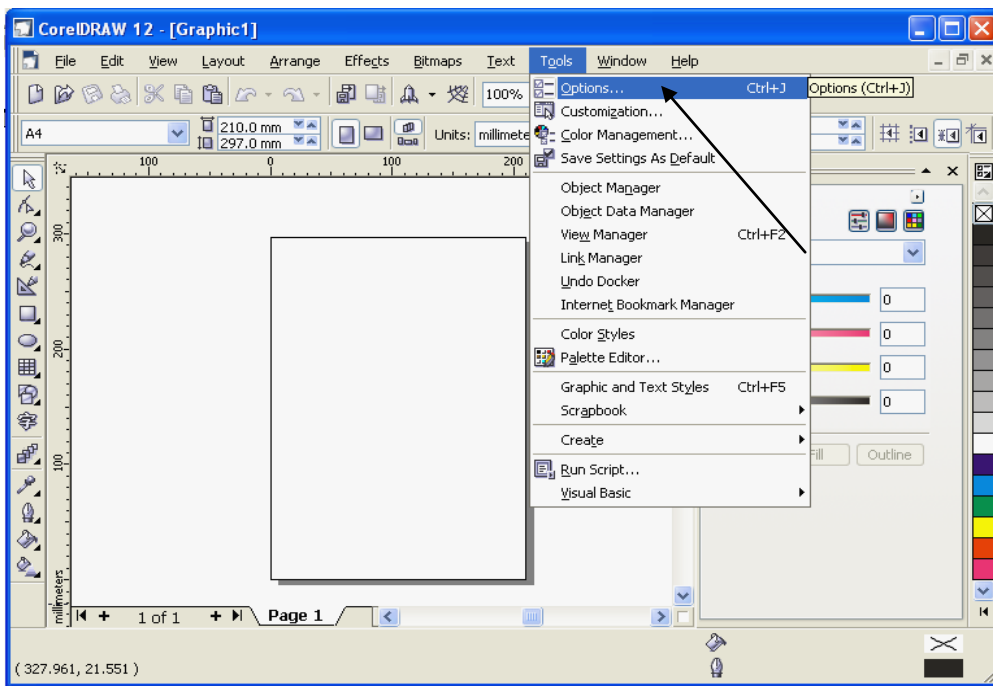

Fig. 3-6

Select “Options” from “Tools” in the toolbar shown in Fig. 3-6 to enter the menu shown in Fig. 3-7.

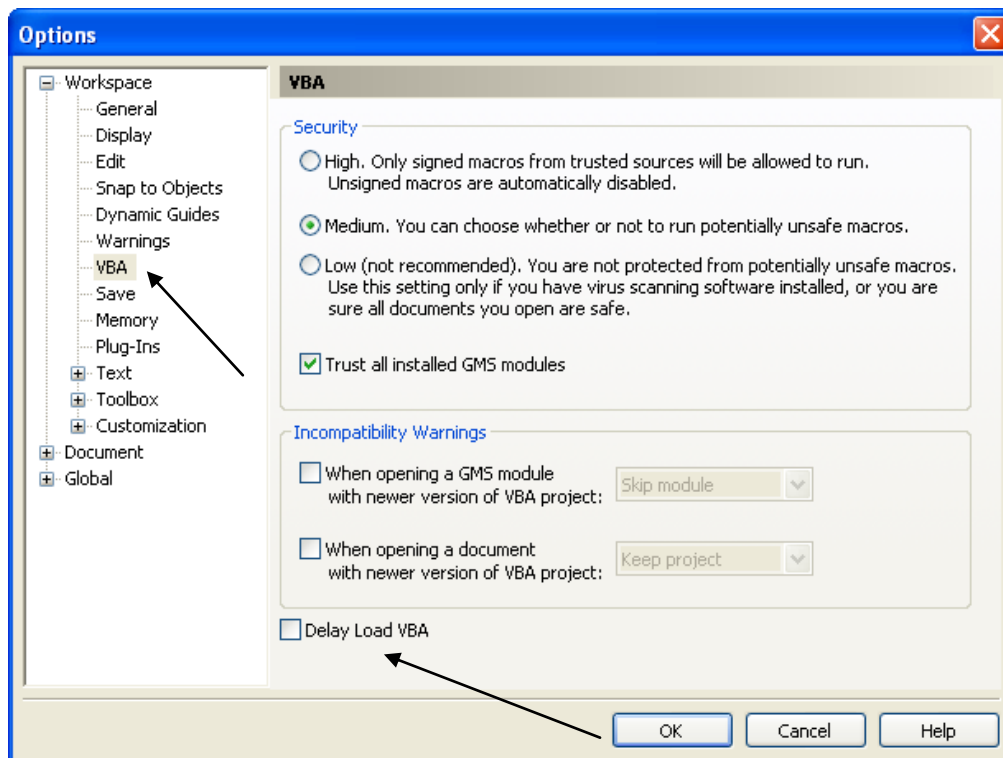



Fig. 3-7

In Fig. 3-7, first click on the “VBA” as pointed out by the arrow in the left, then choose the "Delay Load VBA" at the bottom, the installation is thoroughly completed.

3.2 Uninstalling CorelDRAW Direct Output

Double click on the icon  CorelCamera_V8.7.8.exe of CorelDRAW Direct Output installation software for uninstall, select “Uninstall” and click the “next” to uninstall the software. The CarveNorNor folder in the root folder of CorelDRAW application and the CORELSAVE_NOR folder in Draw folder can be manually deleted if it was needed.

3.3 Installing CAD Direct Output

Now there are two CAD Direct output software available.

- CAD04-06_V8.3.1.exe
- CAD07-09_V8.3.1.exe

CAD04-06_V8.3.1.exe is for installing on AutoCAD2004-2006, now the current software version is V8.3.1—the version is according which program you installed. The version is shown in the installing program name, as you can see in

CAD04-06_V8.3.1—the version is V8.3.1. CAD07-09_V8.3.1.exe is for installing on AutoCAD2007-2009.

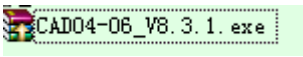
Double click the icon  , to unzip files, then the screen shown in Fig. 3-8 is displayed.

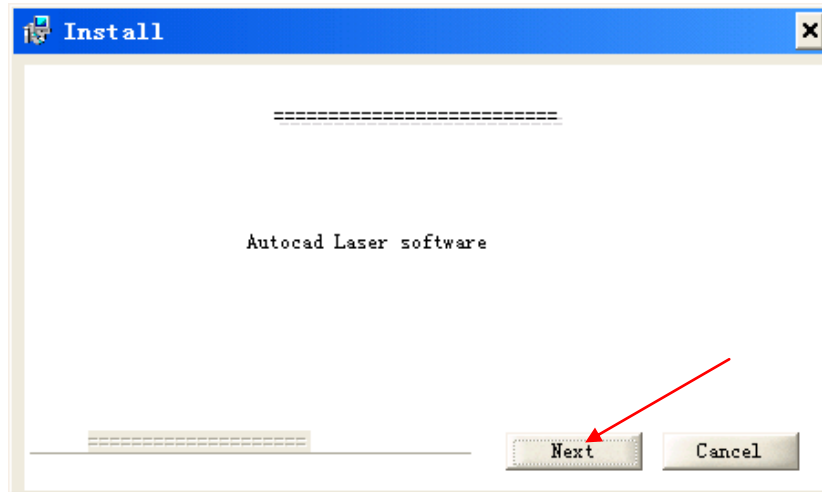

Fig. 3-8

Click “Next” to proceed with installation.

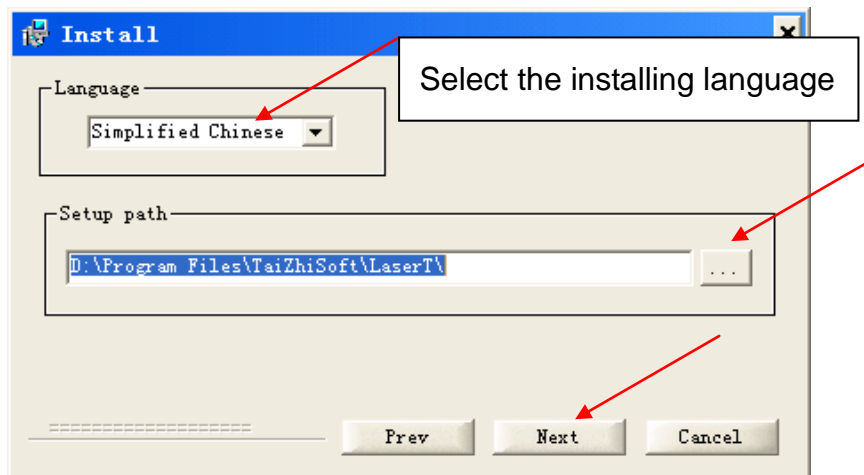

Fig. 3-9

When finished selecting language, click “...” button to select the install path. Then click “Next” to start installing, the installing screen shown in Fig. 3-10 is displayed.

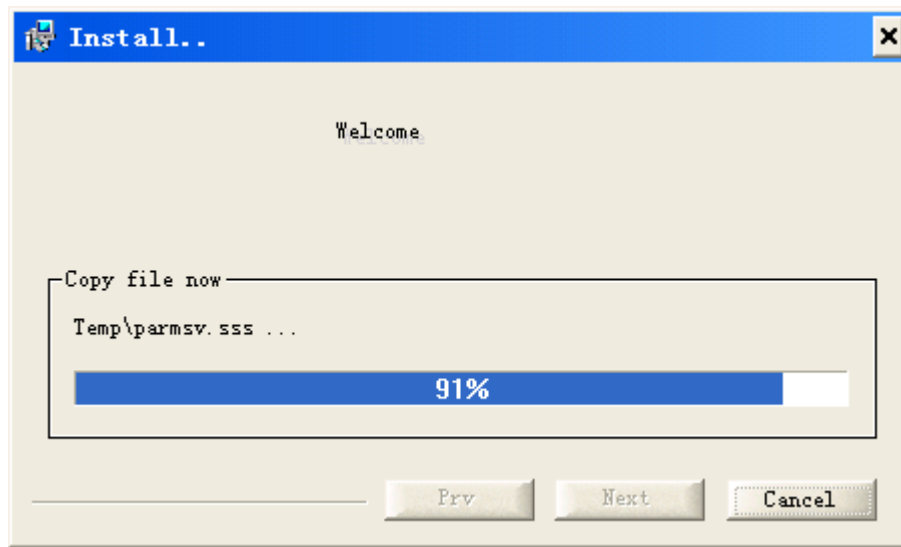

Fig. 3-10

When the installation is finish, the installing program will be closed automatically.

3.4 Uninstalling CAD Direct Output

Click the LaserT Uninstall, show as Fig. 3-11.



Fig. 3-11

Click “Yes” to uninstall in Fig. 3-12.

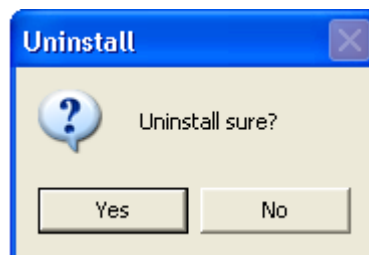

Fig. 3-12

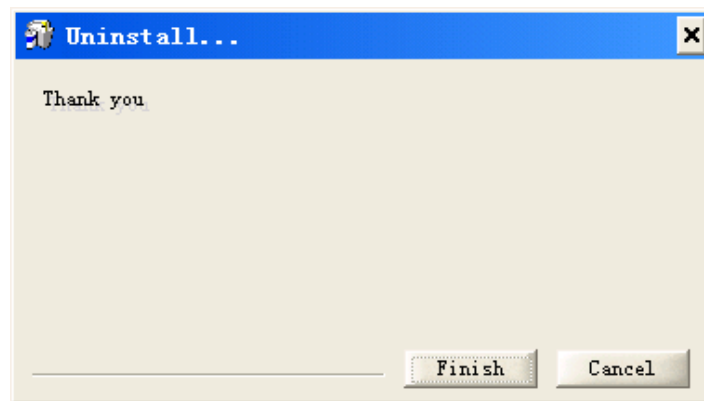

Fig. 3-13

3.5 USB Driver Installation

Insert the USB Cable, the power on, Fig. 3-14 will be shown on the Compute, and then the Fig. 3-15 will be shown:

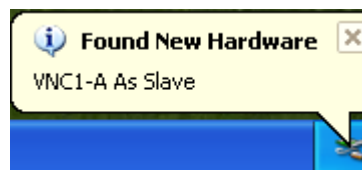

Fig. 3-14



Fig. 3-15

Click the "Next", show as Fig. 3-16

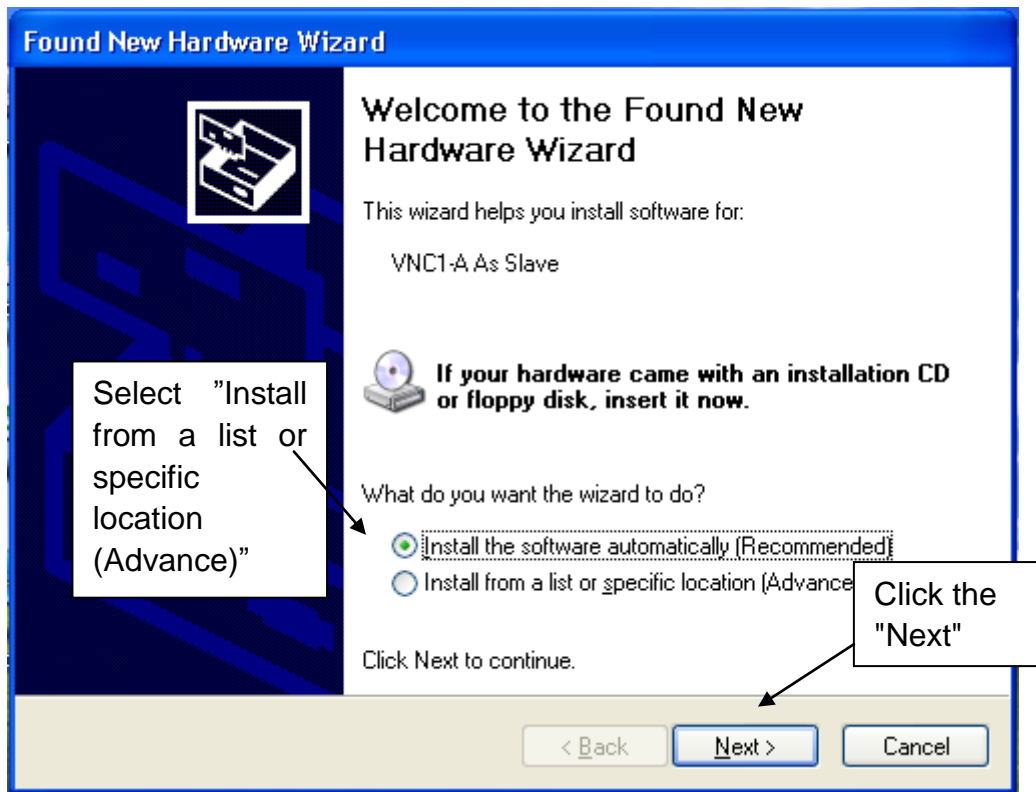

Fig. 3-16

Click the "Next", show as Fig. 3-17.

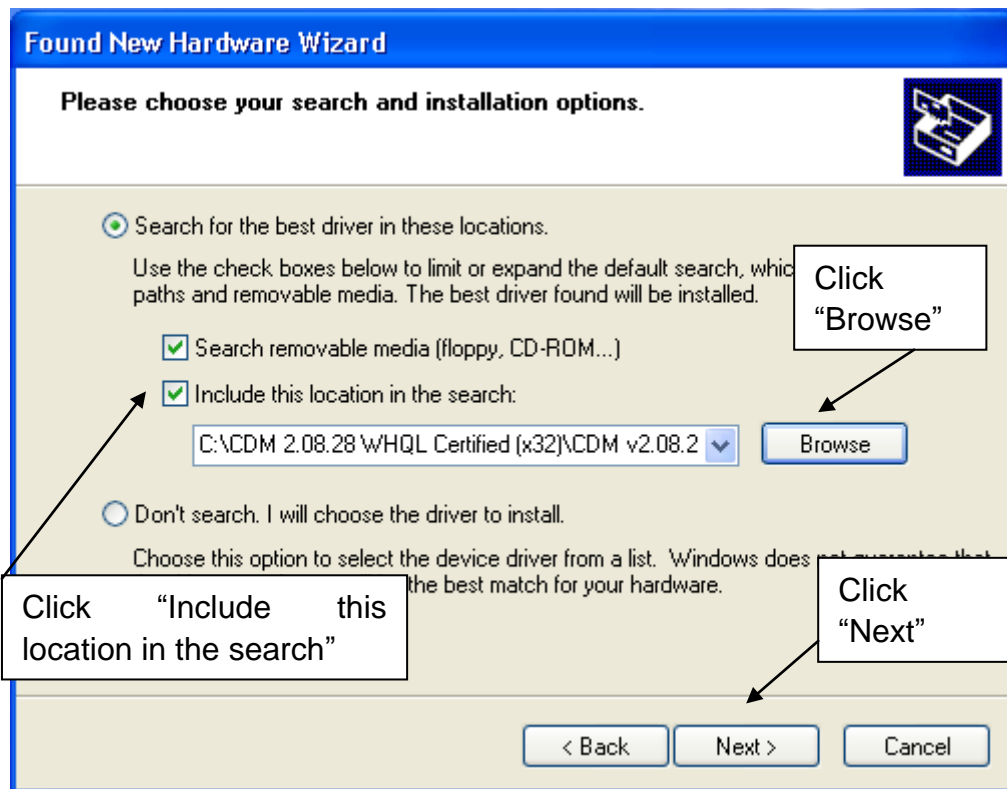

Fig. 3-17

Browse to the USB driver folder by clicking the browse button. Once the file path has been entered in the box, click next to proceed.

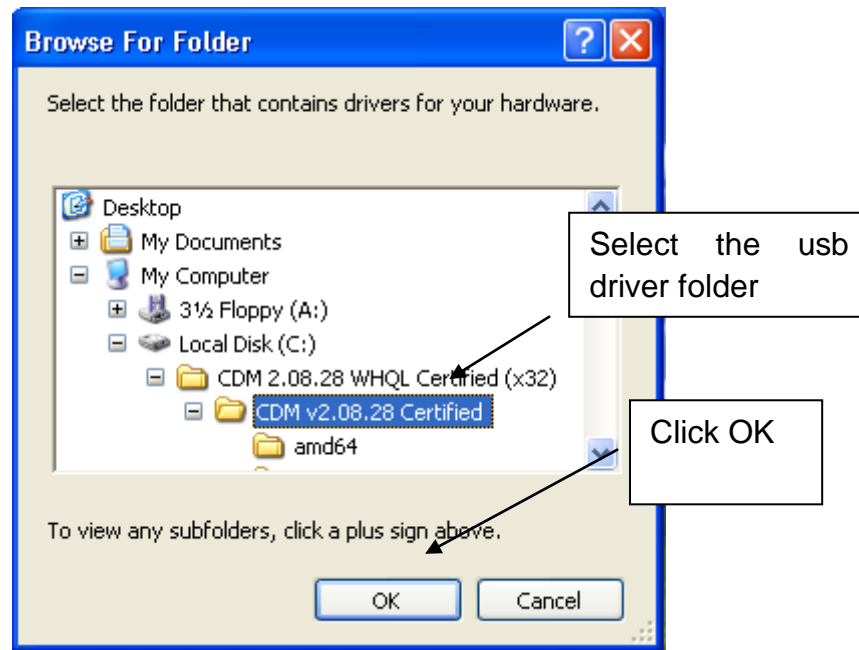

Fig. 3-18

The screen shown in Fig. 3-19 will be displayed as Windows XP copies the required driver files.

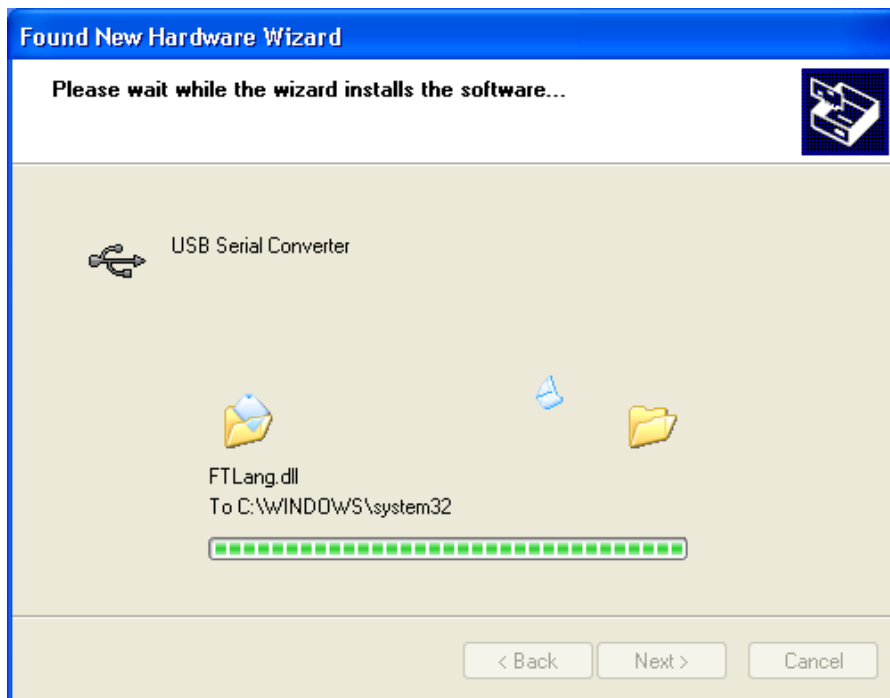

Fig. 3-19

After finishing, show as Fig. 3-20.



Fig. 3-20

USB driver must be installed twice. Repeat the installation steps above once again.

3.6 USB Port Setting

After the engraving card power on, connect the PC with USB cable, the computer will assign a COM port to communicate. But when the assigned COM port is more than COM8, the communication will have problem, so we need to change the COM port number, the range is among COM3~COM9.

3.6.1 View the assigned COM Port by Computer

Enter the control panel.



Fig. 3-21

Double click the "System", show as Fig. 3-22.

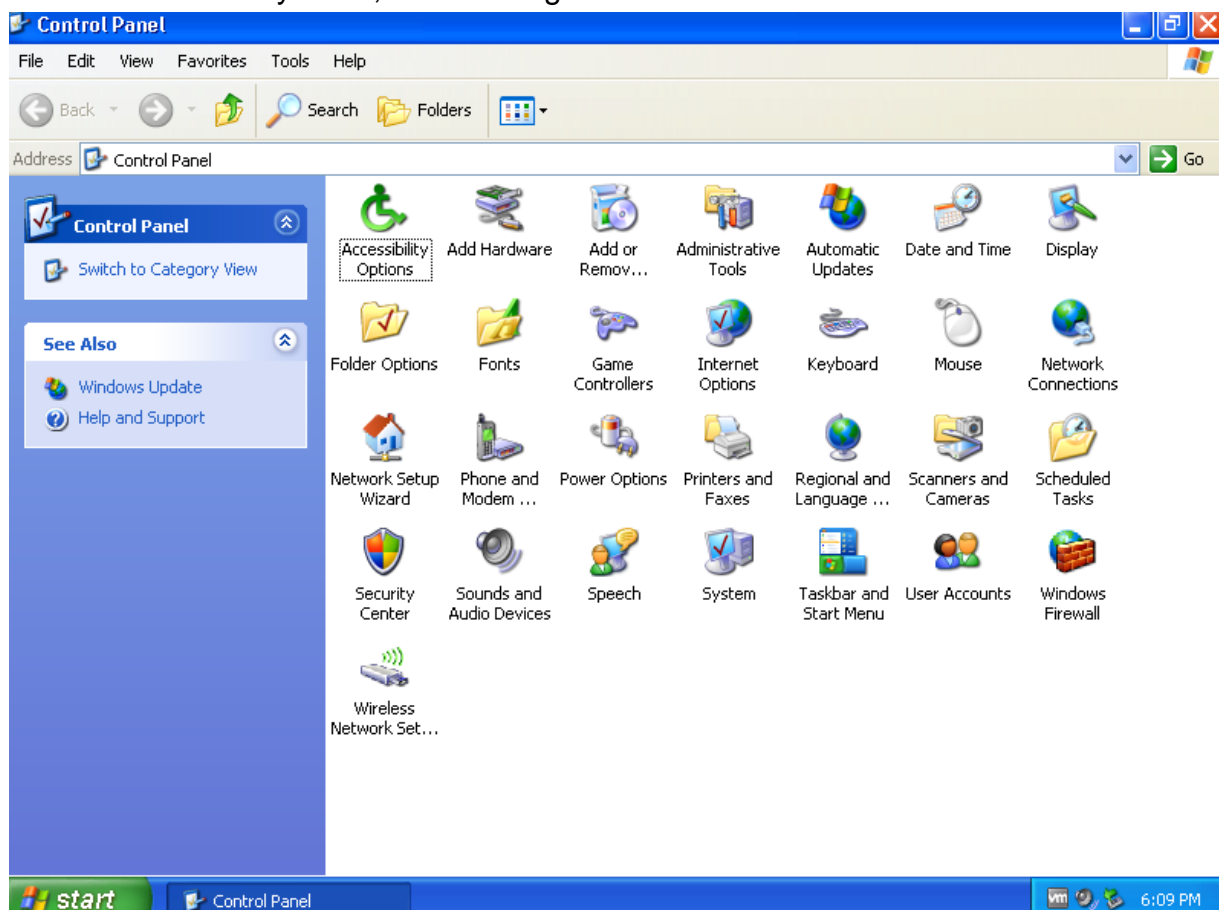

Fig. 3-22

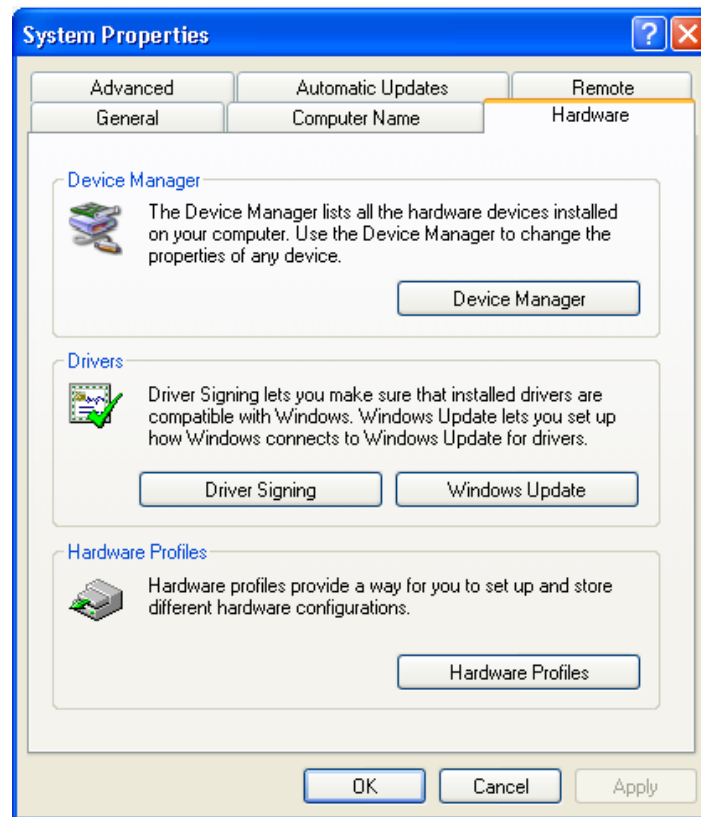

Fig. 3-23

Click the device management.

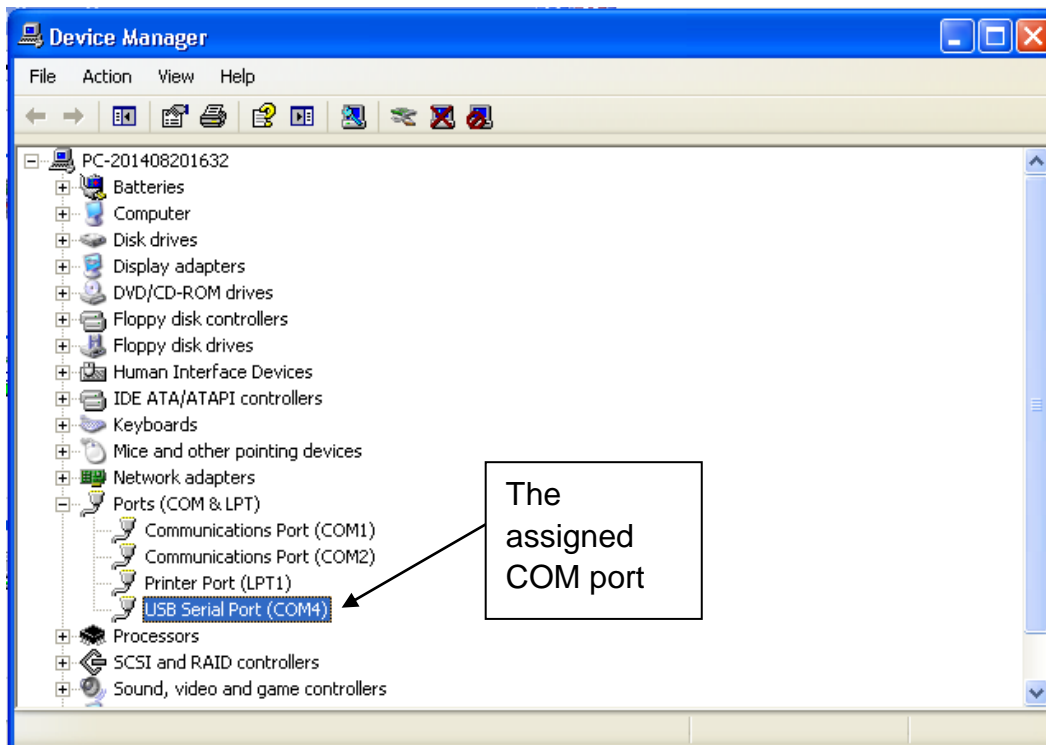

Fig. 3-24

3.6.2 Change the Assigned COM port by Computer

On Fig. 3-24 USB Serial Port(COM4) is the assigned COM port, the way and the steps that change the assigned COM port are as follow:

Double click USB Serial Port(COM4), show a window, single click Port settings, show as Fig. 3-25

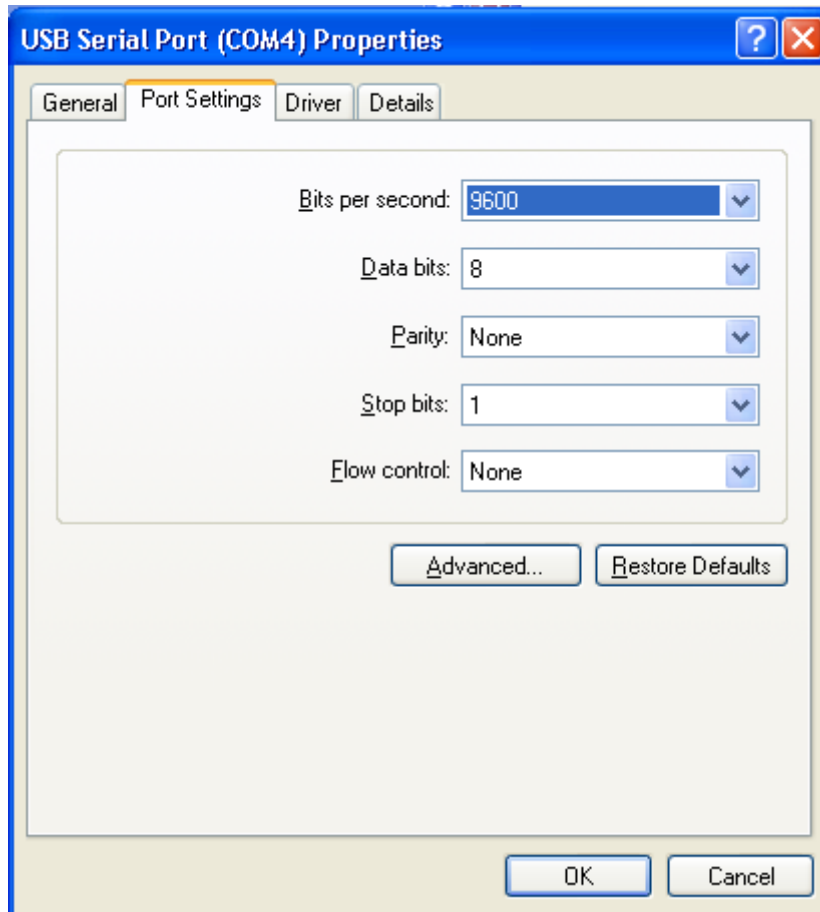

Fig. 3-25

Click "Advanced", show a Advanced Settings for COM4 window, choose the port numbers on the COM Port Number, show as Fig. 3-26.

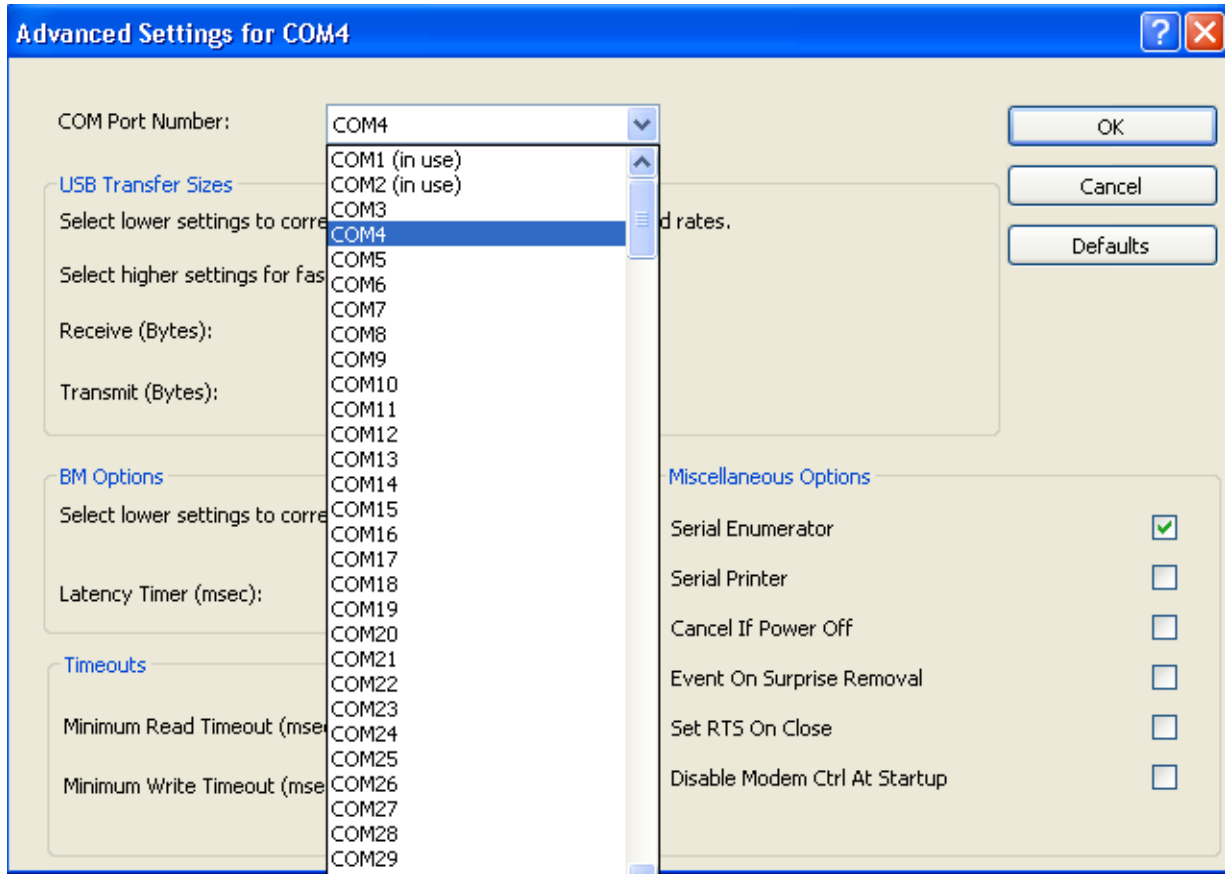

Fig. 3-26

Click "OK", display a window of Communications Port Properties, as Fig. 3-27



Fig. 3-27

Click "Yes" to finish.

3.7 IP Setting

Enter the control panel



Fig. 3-28

Double click network connection.

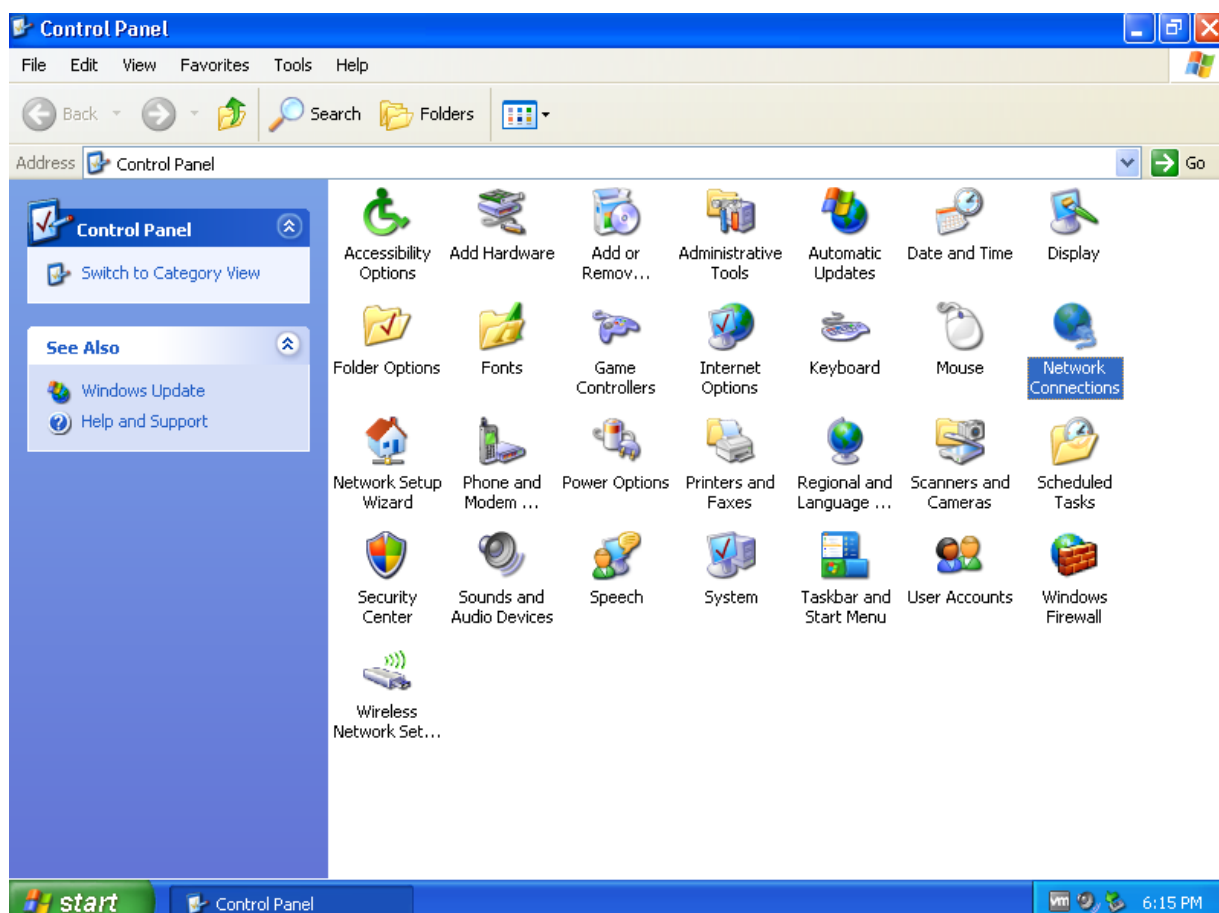

Fig. 3-29

Double click "Local Connection".

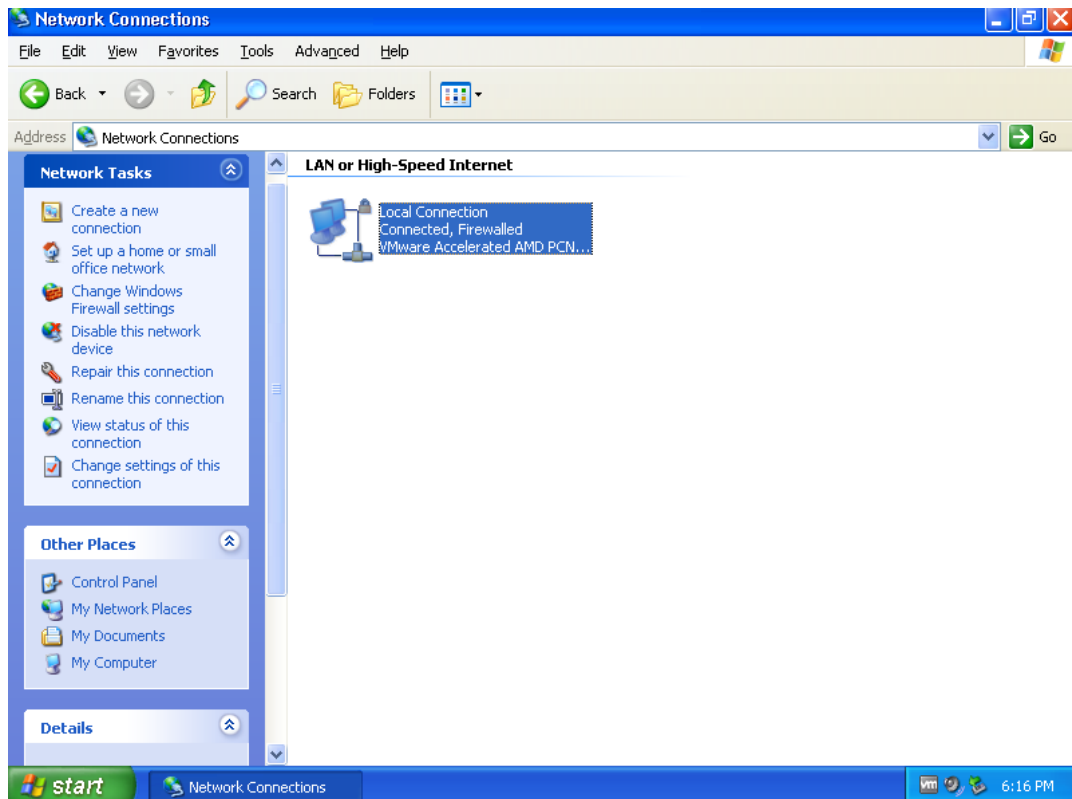

Fig. 3-30

Double click TCP/IP setting.

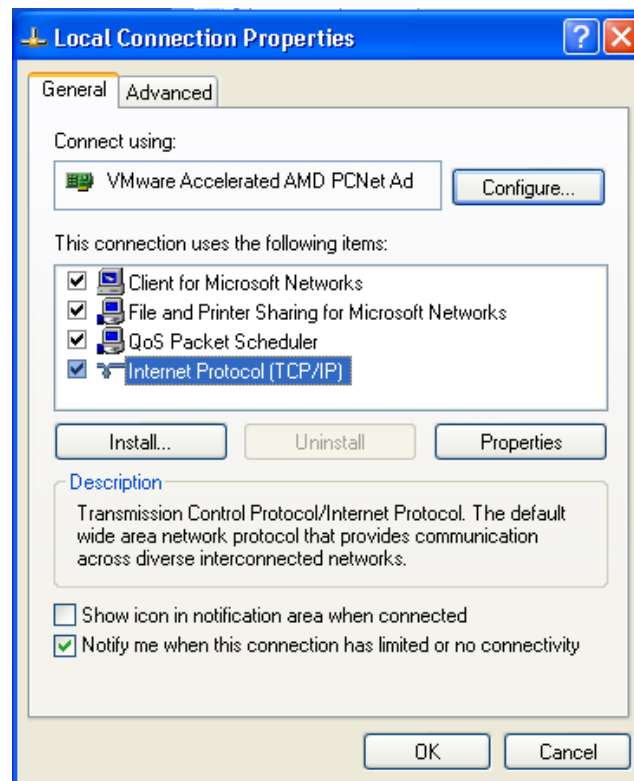

Fig. 3-31

Select “Use the following IP address”, set the IP, Subnet mask, Default gateway, as below figure.

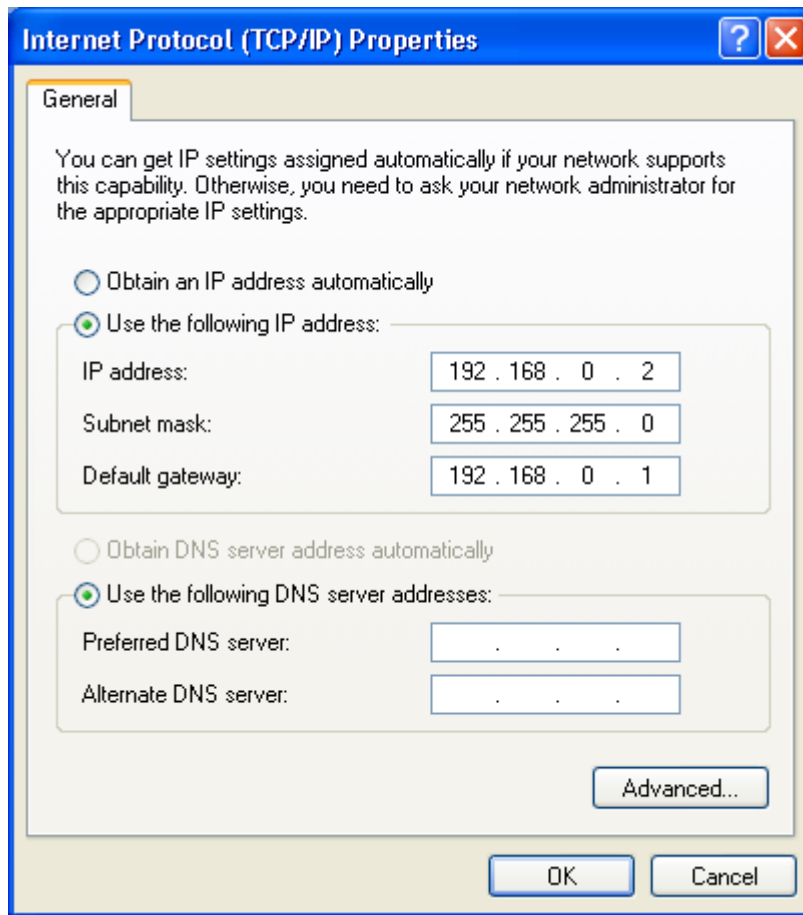

Fig. 3-32

Part 4 Software Operation Guide

4.1 CorelDRAW Direct Output Software Operation

Open the CorelDRAW software, show as Fig. 4-1

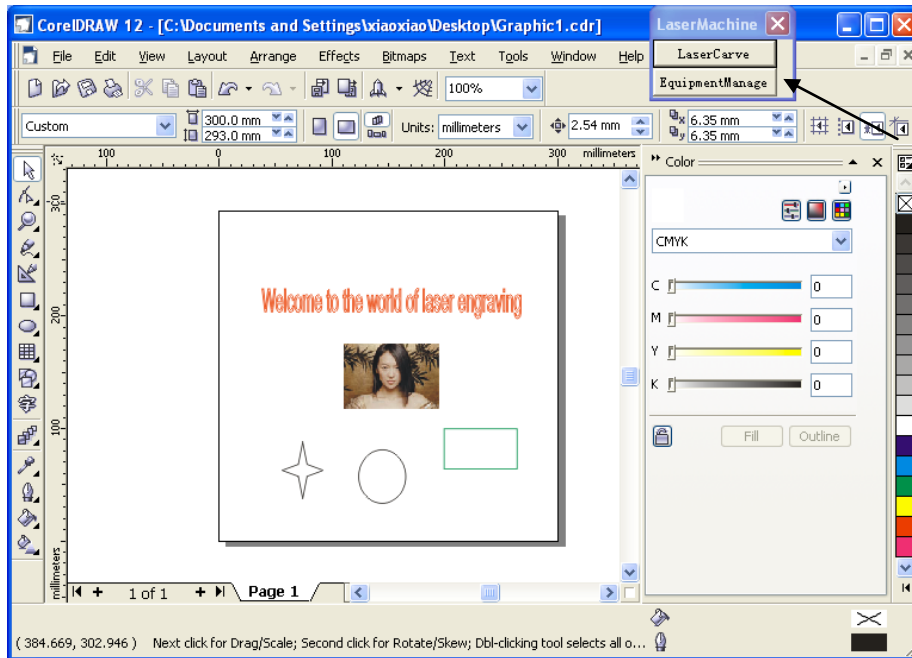

Fig. 4-1 After startup, our processing buttons will be automatically mounted on the menu shown in Fig. 4-1 as pointed out by the arrow. After completing the figure, we can click on the “Laser Carve” button as pointed out by the arrow in Fig. 4-1 to show the menu in Fig. 4-2.

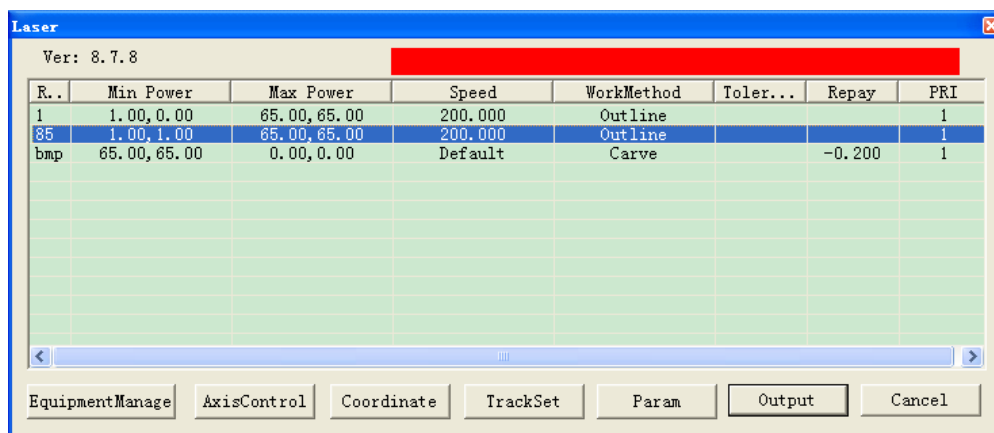

Fig. 4-2

4.1.1 Layer Parameter Setting

It uses different colors for the configuration of engraving parameters, if there are imported bitmaps, there will be independent bitmap settings. You can select a certain color and double click or click on button “Parameter Settings” for settings of these drawings, and then the menu shown in Fig. 4-3 and Fig. 4-4 will be entered.

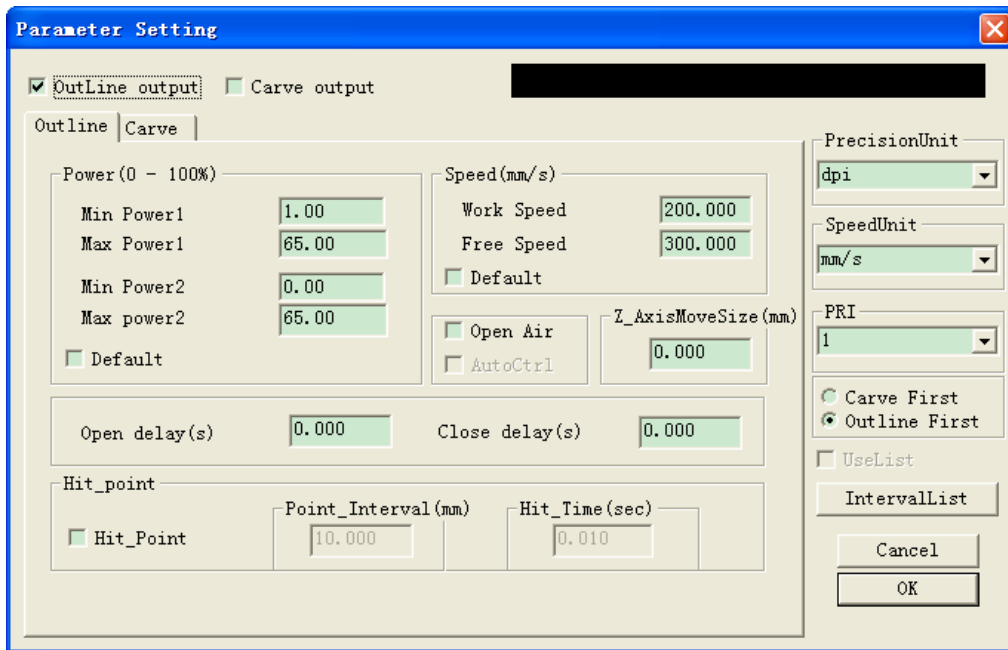

Fig. 4-3

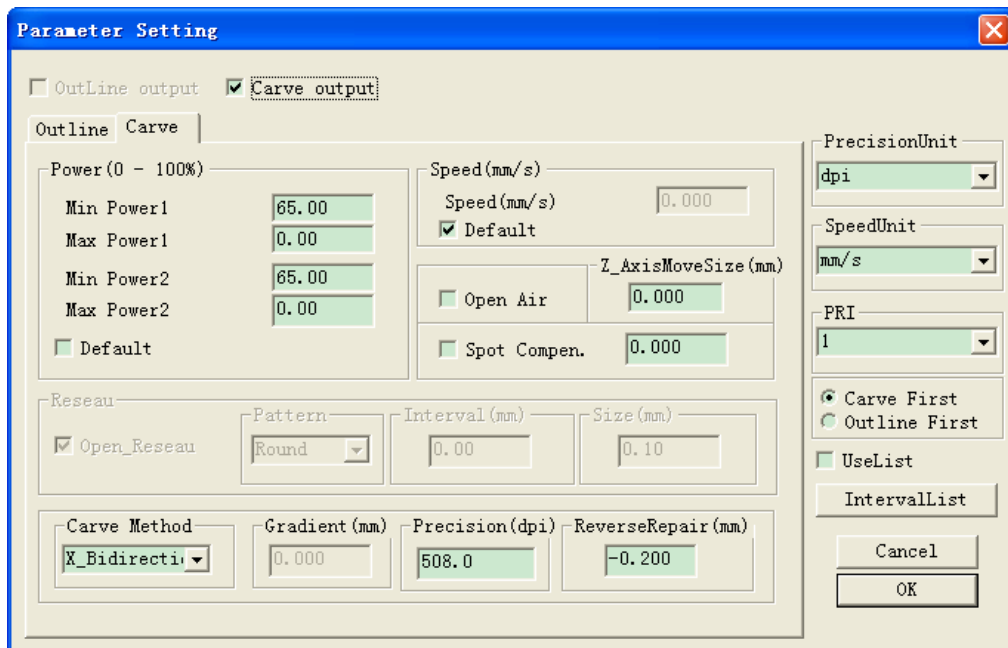

Fig. 4-4

The two most important parameter settings are Outline output and Carve output. If neither of the two is selected, “output disabled” will be shown, i.e., no engraving output for this kind of drawings will be carried out; if both are selected, data in this color will be provided with possibility of both Outline and Carve output, pay attention that there must be closed drawings for Carve. Otherwise, select one of them for one output condition.

PrecisionUnit: the unit of precision of engraving.

DPI(dots/inch): dots per inch

DPM(dots/mm): dots per millimeter

SpeedUnit: the work speed and the free speed unit.

m/minute: meter per minute

mm/s: millimeter per second

PRI: Is used for setting the engraving order of different colors, the smaller PRI, the earlier to be exported, and vice versa.

Those are common settings for colors. “Outline” and “Carve” menus are respectively corresponding to settings for Outline and Carve. For Outline, there are settings for engraving features including speed, power intensity etc., for dots, the dotting time settings are also available; and the settings for Carve follow the same way.

When the check box of “default” is selected, no need to set the power intensity and speed and the default values of the machine will be adopted; settings for power intensity and speed are only available in case the check box of “default” is not selected.

Parameters description:

Output: When selected, engraving output for drawings in the current color will be carried out.

Min. Power: When stroking curves, this power intensity applied for line start and the corner of the curve .Or it applied for the top depth when gradient carving. The range is 0.00-100.00% (Min.Power1 is setting for min power of laser1, Min. Power2 is setting for min power of laser2. Max. power is similar).

Max. Power: When stroking curves, this power intensity is applied as the work speed was reached. Or it applied for the bottom depth when gradient carving. The range is 0.00-100.00%. If the is elbow too deep, it means the Min. power intensity is on the high side or the speed is on the low side. When gradient carving is carried out, the min power must not be set bigger than 30%, the max power can be set bigger, for getting a better degree of gradient carving effect. The gradient rang is 0-3mm.

Work Speed: The work speed of the laser head is cutting. The rang is 0.000 to Axis X,Y limit speed.

Free speed: The move speed of laser head when the laser is off. The range is 0.000 to Axis X,Y limit speed.

Default: If selected, parameters like power intensity and speed etc. will be in accordance with what displayed on the machine.

Open/Close delay: open delay is applied for the head of the cutting line. And the close delay is applied for the tail of the cutting line. The range is 0-15s.

Open Air: when open air check box is click, the blow air signal is active when work is start. There is two ways of blow air, one is the blow air signal is always active. The other is when laser is on the blow air signal is active otherwise not active.

Z_AxisMoveSize(mm): the moving distance of lift axis before work start. When work is finish lift axis move back to the original position. The steps to enable the automatic lifting function is below: Click the AxisControl button at the bottom, then select the Allow_zAxis.,and set the SelectAxis as Z, click OK to back to the parameter setting interface, now it is able to modify the Z_AxisMoveSize. Attention: This function is use to the case of cutting the material with various thickness. By adjusting the position of laser head, to make the laser head move to the position of the laser focal length is reach.

Hit_point: for hit point or drill on material. Firstly click the “Hit_Point” check box. Then set the Point_Interval—interval between dots—and the Hit_Time—laser on timer, unit is second.

Spot Compens.: Spot compensation is for compensating the size lose resulting from the spot is too much big. The unit is mm.

Reseau: In the carve page, it can set the engraving mode to reseau mode. The reseau mod is suitable for closed vector graphics.when the Open_Reseau check box is selected, three parameters below can be set:

- Pattern: Round, Square, Triangle
- Interval(mm): Interval between dots
- Size(mm): the size of dots. When the pattern is round, the size is the length of diameter. When the pattern is square, it is length of edge. When pattern is triangle, it is the edge of external rectangle of triangle.

Carve method:

- X_Unilateralism: Engraving from one horizontal side, when move inversely ,the laser is off. It can eliminate backlash and the processing effect is good, but the processing time is longer.
- X_Bidirectiona(recommended): Engraving from both horizontal sides. The processing time is short. But because the machine generally exist backlash leads to dislocation. At this time you need to set up a backlash or backlash list.

- **Y_Unilateralism:** Engraving from one vertical side, when move inversely ,the laser is off. It can eliminate backlash and the processing effect is good, but the processing time is longer.
- **Y_Bidirectional:** Engraving from both vertical sides. The processing time is short. But because the machine generally exist backlash leads to dislocation. At this time you need to set up a backlash or backlash list.

Gradient(mm): the gradient length of gradient engraving, as shown in figure below. When carry out gradient engraving, the top depth is determined by the min power. The larger the min power, the deeper the top depth. The Depth from top to bottom is determined by the max power. The larger the max power, the deeper the depth. The gradient length determines the distance from the top to the bottom, the greater the distance, the slope more flat.

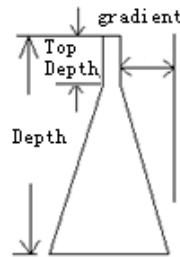

Fig. 4-5

Precision: the precision of engraving. The unit is DPI or DMP. It means how many lines will be processed per inch or per millimeter. For example, 500 DPI means it will process 20 lines within 1 millimeter length. The greater the precision value, the deeper the engraved depth.

ReverseRepair: use to compensate the backlash of the machine. The debug step is as follows.

- Draw three 50X50 rectangle in CorelDRAW, select the carve output check box in parameter setting window. And set precision as 2 DPI, ReverseRepair as 0. Then output the file to control card.
- The actual processing effect is similar to the figure below. The length of first line and second line dislocation in the middle rectangle is the compensated length. Generally it is negative, according to the engraving effect to set it. As the figure shown below, the length is -0.2mm. So the ReverseRepair is -0.2.

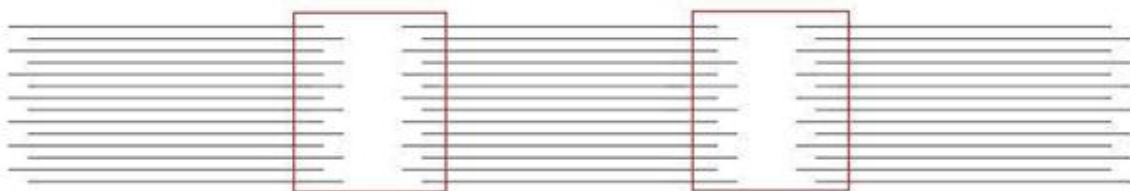

Fig. 4-6

- When finish setting the ReverseRepair, set the appropriate value of max power and precision. Generally, 60W CO2 laser, 53.5 Focus lens, 350DPI is recommended. The greater the precision, the longer the engraving time.

IntervalList: select the UseList check box then the IntervalList setting is applied to the engraving file. In this case, the ReverseRepair is useless. The function of IntervalList is similar to the ReverseRepair, use to adjust the engraving effect. In the list of IntervalList, it can set the backlash in different speed. Because of working in different speed, the backlash is different. The greater speed, the bigger the backlash.

After the parameter settings, the engraving output can be carried out, the system will remember the last parameter settings to avoid repeated parameter settings. For instance, if you set the red output power intensity at (50%, speed at 20%, no error compensation and PRI at 1), the same setting will be applied for the use of the color red (if any) for the next time.

4.1.2 Coordinate Setting

According to actual situation, just click on the “Coordinate” button in Fig. 4-2 to enter the menu shown in Fig. 4-7. If the machine homing to the upper right, select Right-Top in the group of coordinate.

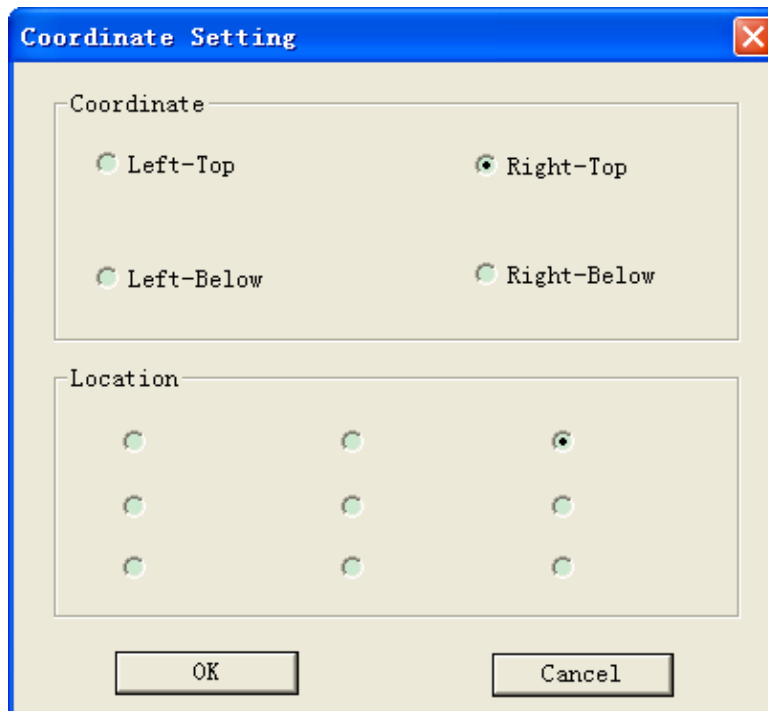

Fig. 4-7

There is 9 location can choose. If you set the location in upper right, the output file will be processed in the lower left side of the laser head. As shown in Fig. 4-8.

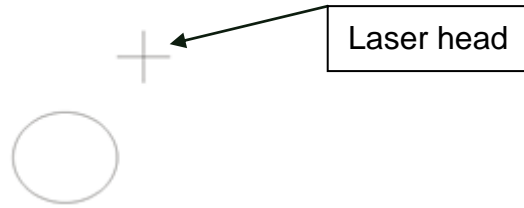

Fig. 4-8

4.1.3 Track Setting

Click the “TrackSet” button in Fig. 4-2, a track setting window will be shown. It can set the cutting order and the cutting start point of the line in different shape or layer. As shown in Fig. 4-9.

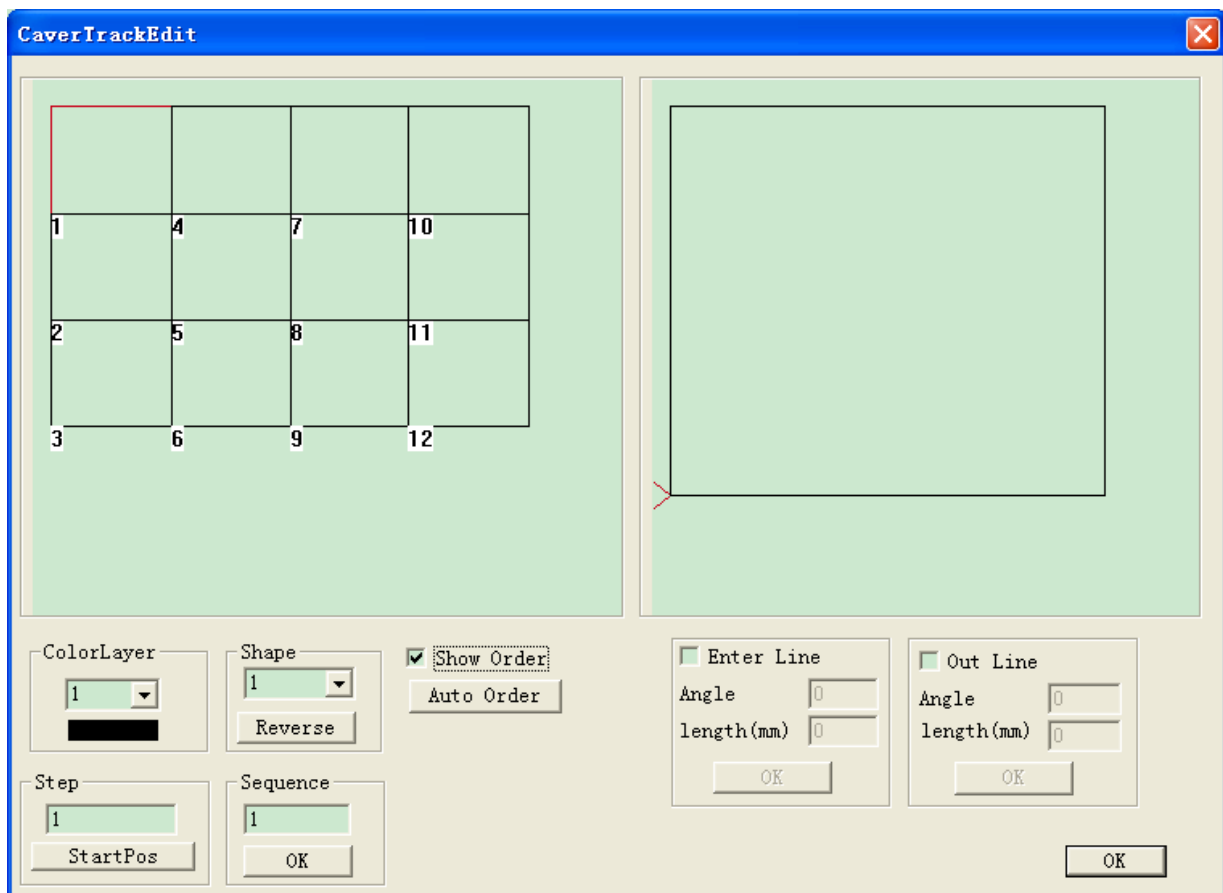

Fig. 4-9.

ColorLayer: Select the color layer number you want to adjust. It will display all the shapes in this layer in the upper left window.

Shape: Each shape has a serial number. It means its processed order in this layer.

Select a serial number in the shape drop-down box. Then the shape with this number will be displayed in the upper right window. And the red arrow shows the start process point and the direction of cutting.

Show Order: Select show order check box. The serial number of the shape will be shown side by the shape in the upper left window.

Auto Order: click the auto order button, the program will automatically optimized cutting sort all shapes.

Step: Specify the start processing point of the shape. The unit is the line number. When set the step as 1, click the “StartPos” button once, the start processing point will move forward 1 line segment on cutting direction.

Sequence: Specify the process order of the select shape. Set the proper value of sequence, then click ok button. At this time, the upper left window will display the new processing order of shapes (the Show Order check box is selected).

Enter Line: When Selected the enter Line check box, an extension line will be added before the shape. It is used to avoid the laser light is not stable, lead to processing problems. Set into the angle and length of enter line, click ok button below to complete setting.

Out Line: When Selected the enter Line check box, an extension line will be added after the shape. It is used to avoid laser burn twice at the same place of the start position of close shape, lead to overcut problem. Set into the angle and length of out line, click ok button below to complete setting. Generally, the enter line and the out line is less than 10mm.

When finish setting, click the ok button in right bottom to save the configure.

4.1.4 Single Axis Operation

Click the “AxisControl” button in Fig. 4-2, a track setting window will be shown. It can separately operate the single axis moving, show as Fig. 4-10:

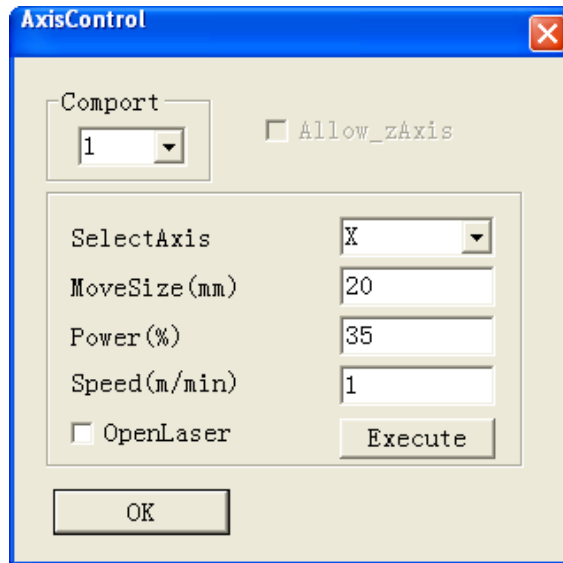

Fig. 4-10

Firstly select the com port which is the USB port described in section 3.6. Then select the axis you want to move. Set the move distance in MoveSize edit box and the move speed in Speed edit box. If you need the laser on, set the laser power in Power edit box and select the OpenLaser check box. Click Execute button to move. If you want the axis move to the reverse direction, set a negative value in the MoveSize edit box.

4.1.5 Output Engrave

After the parameter settings, click on “output” to enter Fig. 4-11

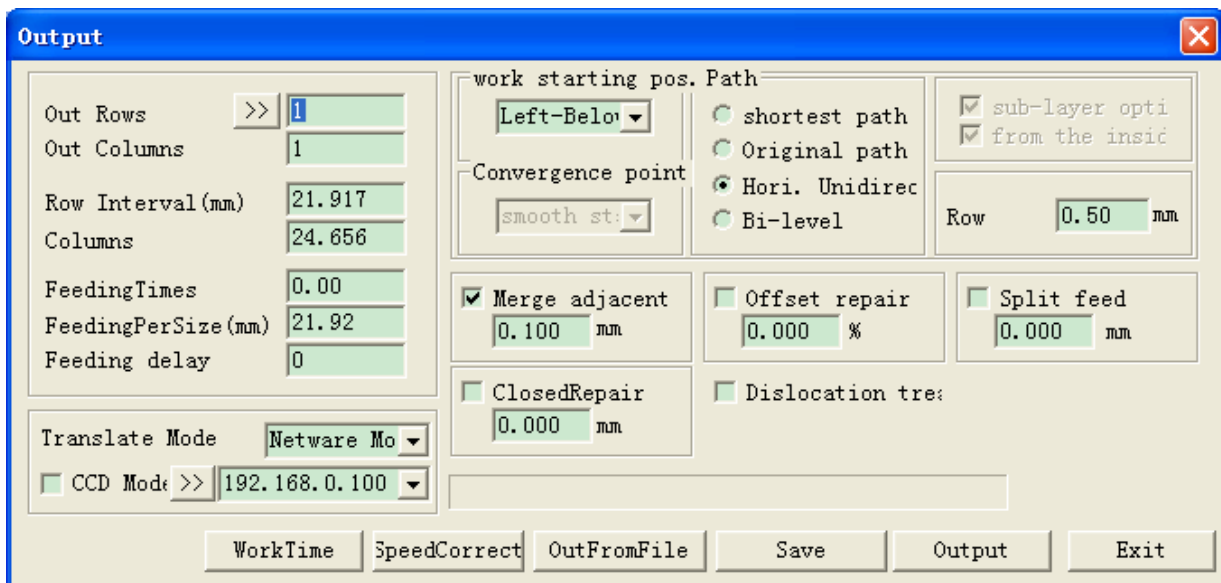

Fig. 4-11

Parameter description:

Out Rows: The rows of the output shape.

Out Columns: The Columns of the output shape. By default, the row and column is 1, it means the shape will be processed once.

Row Interval (mm): The interval size of row. The unit is mm.

Columns Interval (mm): The interval size of column. The unit is mm.

FeedingTimes: After finish one process, the machine can feed once. The feeding times parameter determines how many time it will feed.

FeedingPerSize(mm): the feeding length.

Feeding delay: The delay time after feeding. The Unit is second.

Attention: These parameters above are applied to array process or repeat process. Here, the row and the column is array parameters. If row is 2 and column is 1, then 2X1 array work file will be outputted. The row interval determines the distance between two rows. The columns interval determines the distance between two columns. Feeding Times, FeedingPerSize, Feeding delay is applied to the machine with feeding equipment. Feeding Times is repeat work parameters. Click the “>>” button for more array setting. As shown in figure below, it can set the table size—table width and length, work start position, row, column, row interval, column interval. Click the Import button or Auto-filled button to preview. Click ok to save configure.

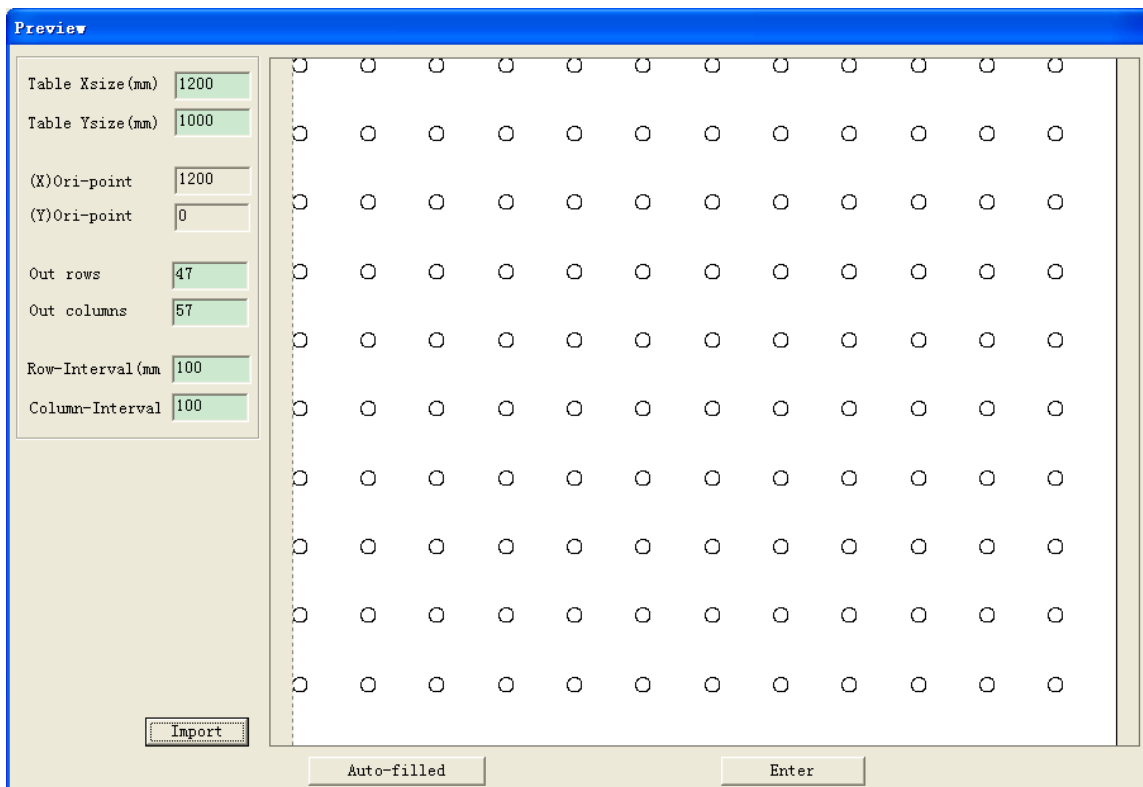



Fig. 4-12

Translate Mode: The communication mode for download file from computer to control card. If USB mode is selected, it can select the com port in the drop-down box—corresponding to the visual serial port created in the Device Manager of the computer. If Netware mode is selected, it can select the IP of the machine you want to download file to. Or you can set click the  button to add or modify the IP address of the machine. **If the control card is camera cutting card with the version is V.L010.XXX, then the CCD Mode check box must be selected. Otherwise, the output file will not be identified by the card.**

Path:

- **Shortest path:** The program will automatically calculate the shortest cutting path of the output shapes. The following options can be set.
 - **Work starting pos.:** laser head work starting position (Left-Top, Left-Below, Right-Top, Right-Below).
 - **Convergence point:** The data handle between ending position of the current shape and starting position of next shape.
 - ◆ **The starting point:** The distance from ending position of current shape to starting position of next shape is shortest. The free move time is shortest.
 - ◆ **Smooth starting point:** Select the optimal starting position of next shape to realize smooth moving, avoid shake or dislocation
 - ◆ **Original starting point:** no change the starting position of the shape.
 - **Sub-layer optimization:** First according to layer order to sort. Then optimize the cutting order inside the layer.
 - **From the inside out:** If the shapes have the containment relationship, the inside shape will be cut first. This guarantee will not happen cutting error or missing cutting.
- **Original Path:** Not optimize the path, using drawing order.
- **Hori. Unidirectional:** cutting from one horizontal direction for array process (T shape).
- **Bi-level:** cutting from bilateral horizontal direction for array process (S shape).
 - **Row:** When the select the Hor. Unidirectional or Bi-level, it can set the Row parameter. It means the width of the partition optimization. If you want to cut the shapes within 100mm range, set the row is 100mm. So the machine will have cut all the shapes with 100mm row size, then it moves to cut next shape within next row.

Merge adjacent: set this merged range so that two line will be merged into a line if

they meet the requirements. This is helpful to reduce the nodes within a shape and make the not closed graph to closed graph.

ClosedRepair: Set the compensated line length for compensating the process error leaded by the mechanical parts. This is helpful to make the not closed graph to closed graph.

Dislocation treatment: For avoiding closed graph processing dislocation phenomenon.

Offset repair: When feeding, material will send partial due to mechanical movement. Offset repair parameter is used to correct the feeding error. The unit is %, the greater the value you set, the greater the compensation.

Split feed: If the graph is so long, it needs to split feed. Set the split length. And the graph within the split length range will not be split. Make sure the dimension of the length is not greater than Y, otherwise it will be forced to split. Under the specified length, cutting out a layout of the graphics, and then feed, and then cutting the next layout of the graphics. Generally, the split length is length of the longest graphic.

In the bottom of the window, there are some buttons. The description is following:

WorkTime: Predicting the processing time.

SpeedCorrect: Click it then it shows a speed setting window. Set the speed limit when cutting the little graph. It is useful to avoid shake.

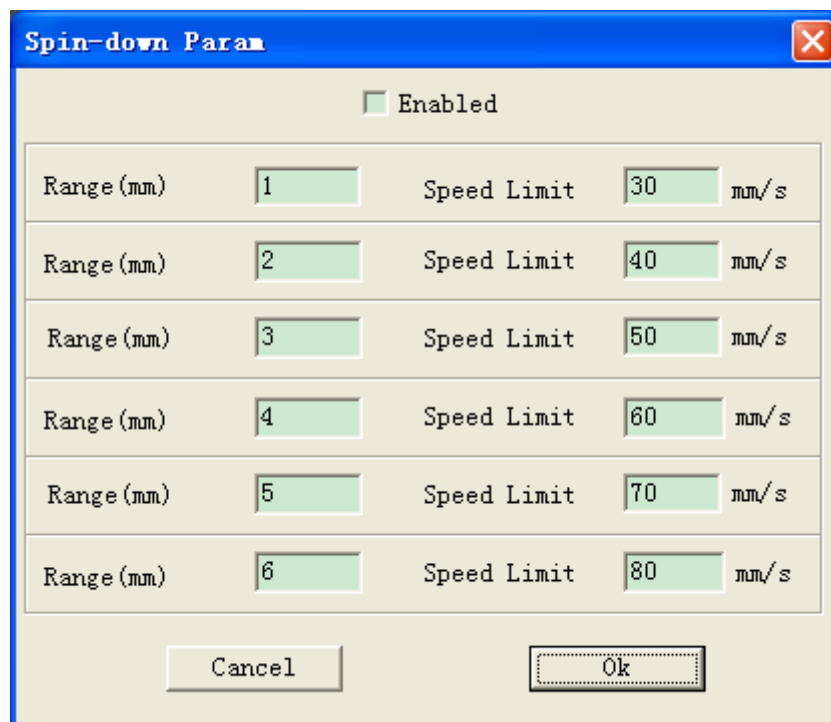

Fig. 4-13

OutFromFile: Download the *.out work file to control card.

Save: Generate a work file from current drawing and save the work file in computer.

Output: Click it and a window is shown. Doc name is assigned by the program, can be modified. Press “OK” to download file to control card. After the completion of the transfer, control card will beep on. Press File button on the card panel, you will find the downloaded file at the last. Select it and press “start” to process.

Exit: Close the output window.

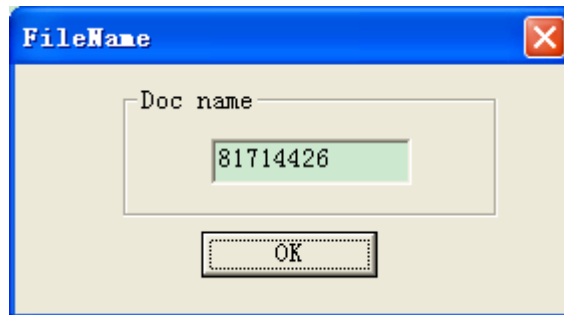

Fig. 4-14

4.2 The Equipment Management

This section describes the parameter settings of the laser engraving software and the operation of the parameter setting software. **These settings are very important because the parameters of the machine will decide the working status of the engraver, therefore, please read carefully this chapter and do not make any change before you completely understand the meanings of all the parameters.**

Enter the machine parameter settings when clicking on the “Equipment Manage” in Fig. 4-1 above.

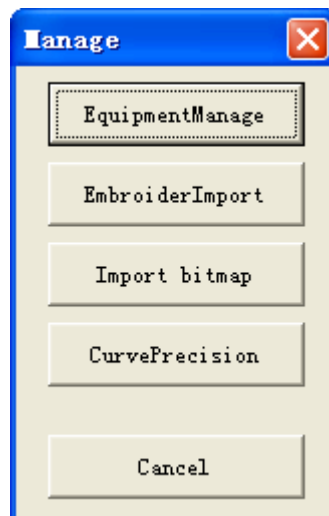



Fig. 4-15

The equipment parameters are the core settings of the engraver, the user needs not to modify them in normal cases, if the modification is necessary, please prepare a backup for correct parameters in advance, if the equipment cannot work normally after the modification, you can rewrite the backup data into the engraver.

Open the parameter settings menu (Fig. 4-16、4-17). This software functions to make settings for the equipment parameters of Topwisdom laser engraving software.

4.2.1 Toolbar

There are 3 buttons in the tool bar , respectively representing: factory settings, open file, save file and exit.

 Factory Settings: Reference values or limit values for the parameters set by the factory, the user cannot modify the factory settings but can use them as reference.

 Open File: Opens the backup parameter files saved in the computer.

 Save File: Saves current parameters to a file.

4.2.2 Parameter Setting

See Figure Fig.4-16 for the factory settings

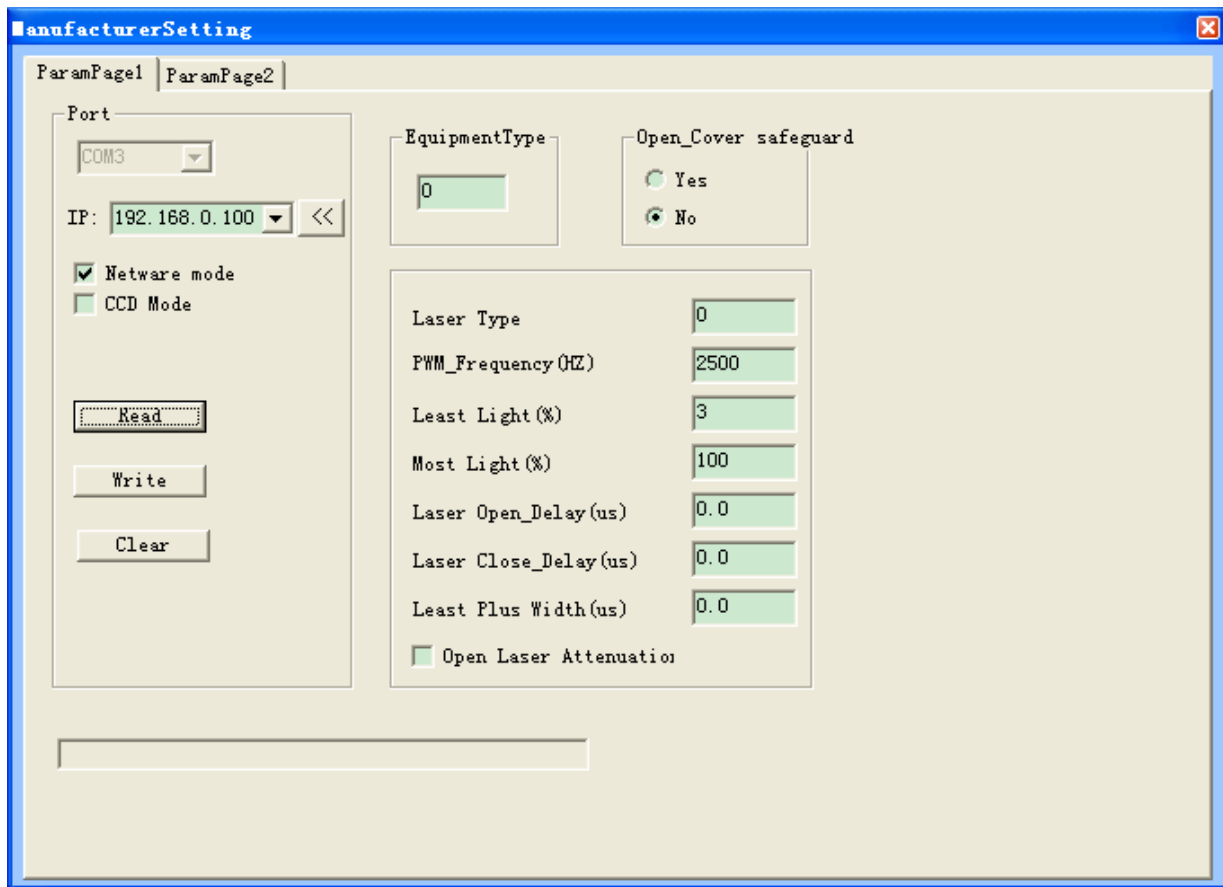

Fig. 4-16

Port: It's the communication interface between the computer and the equipment, which is realized via the port, namely, the image information and the equipment parameters on the computer are transmitted to the equipment via the port. Topwisdom laser engraving software adopts USB interface or network for the connection with the computer.

IP: Set the control card IP.

Netware mode: use network to communication.

CCD mode: for Camera cutting control card.

Read: Read the parameters saved in the equipment and display the values to the user for reference. If you need to modify the parameters, you must read the parameters in the equipment or open the parameter files already saved first, and then modify the parameters (If read failure, please check if computer is connected to control card by the USB cable or network cable).

Write: Write the parameter values set by the user into the equipment (authorizing code provided by the manufacture is required: TZ0001), and then the equipment will operate according to the parameters written into it. When the parameter settings of the equipment is not completed, click on this button, and the "Some Data is Invalidate" will

be shown in the status bar at the bottom, the parameters cannot be written into the machine.

Clear: Besides the drop-down box option, the rest of the parameter value will be set to null, which is no parameter values.

※ Topwisdom software uses serial ports for writing and reading, therefore, once a kind of software is using a serial port, other software cannot use this serial port.

Equipment Type: type of the used machine. There are mainly general engravers and brand engravers.

Open_cover safeguard: If Yes is selected, whenever the cover is open by user, machine will start the safety protective measures, to pause working. In the case of equipment with safety protection, which do not use the open protection, user can also will set the Open_cover safeguard parameter as "No". Such as test equipment, test process, but this operation must be performed by the professionals, generally don't recommend customers to use.

Laser Type: Select proper laser device type according to the laser device used by the machine.

PWM Frequency: I.e., the power intensity frequency of the laser tube, this value differs according to different types of the laser tubes; please consult the instructions for the laser tube for details.

Least Light: The min. duty ratio supported by the engraver.

Most Light: The max. duty ratio supported by the engraver.

Laser Open/Close Delay: the delay parameter set to avoid the uneven edges of the first Outline and the last Outline when the laser is on or off.

Laser on Delay: Because it takes a short period to start the laser, in order to make the power and the laser head be started synchronously, the laser device is started before the laser head. I.e., the Laser On Delay.

Laser off Delay: Because it takes another period of time to shut off the laser after receiving the instruction, in order to avoid excessive engraving, the laser is shut off in advance.

Least Pulse Width: The min. pulse width to be recognized by the laser device.

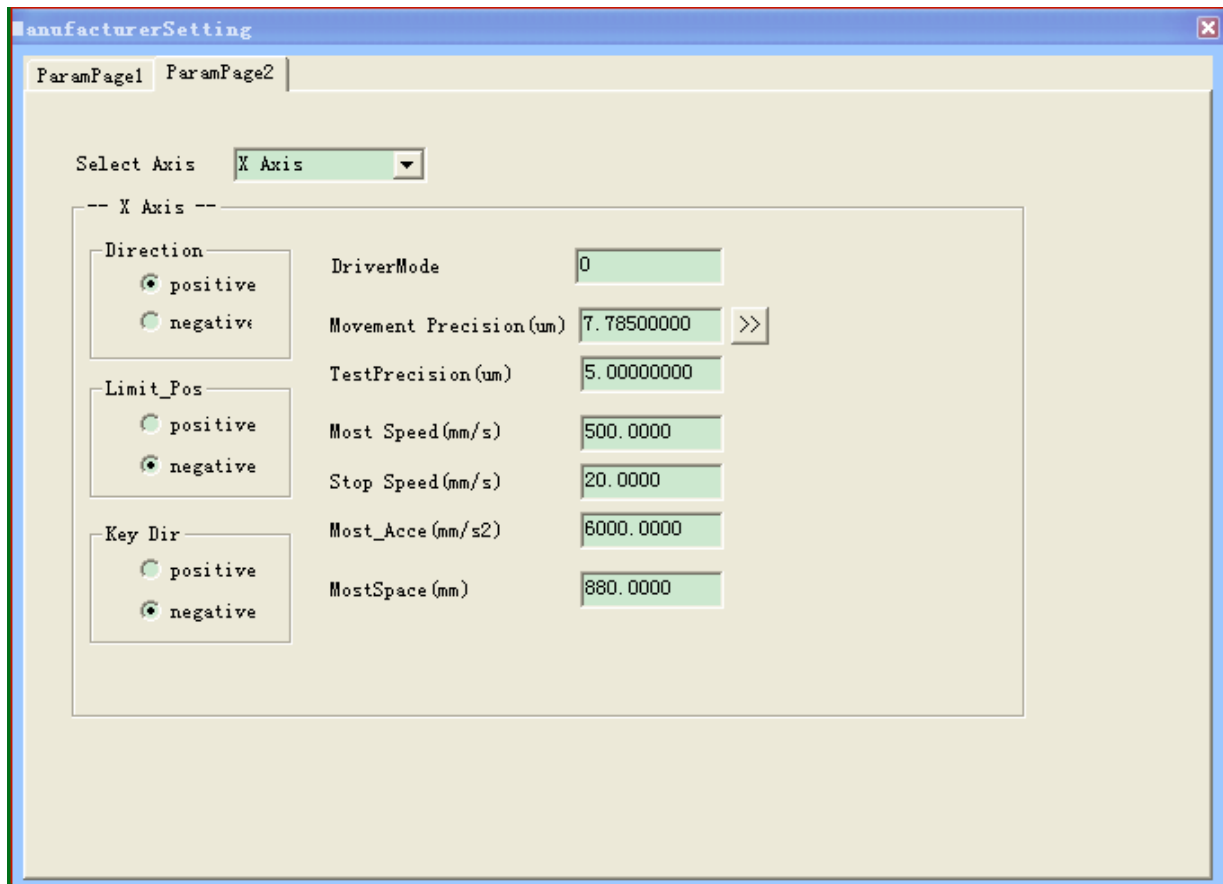

Fig. 4-17

Direction Polarity: Classified into positive and negative, when the motion direction of the motor disaccords with the direction control buttons on the keyboard, you can change the direction polarity to make them consistent with each other.

Limit Polarity: Classified into positive and negative, when the motor cannot return to the original position, you can change the limit polarity to make it normal.

Key Polarity: The buttons on the control panel correspond to directions of the motion of the axes, if it moves to the right when you press the left, change the polarity.

Note: set the limit polarity first, then direction polarity, and key polarity last.

Movement Precision (μm): The move distance per pulse, the unit is μm . The resolution of machines may be changed slowly due to different abrasion and other factors of machines, the user may get the optimal value after multiple times of debugging and settings.

Calculation of Resolution: Accurate Resolution = Current Resolution \times Real Size/ WishSize.

Current Resolution: The resolution set at current operation of the equipment, i.e., the resolution in the parameter settings of the equipment, which can be read from the

equipment.

RealSize: The length on the effect drawing designed by the user, normally in whole numbers but not exceeding the max. travel.

WishSize: The length of the track left by the engraver on the engraved material, which can be measured by measuring tools.

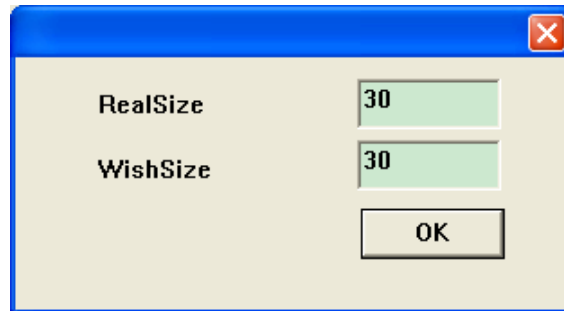

Fig. 4-18

About the size of the measuring:

Draw a 30*30 rectangle to calculate the resolution. When measuring, the width of the laser beam needs to be considered. The processed reactangle is as shown in figure below. Take the measured value of the X axis 34mm, and input 34 into the RealSize edit box and 30 into the WiseSize edit box. Click ok the program will calculate out the right resolution. Other Axis is similar. When calculate the resolution of Y, the RealSize is the length of trace the beam moved.

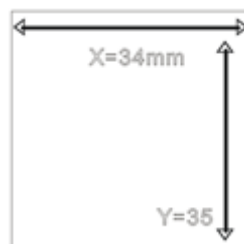

Fig. 4-19

Test Precision(μm): This parameter is valid when the equipment is provided with the closed-loop detection system, this parameter finally decides the errors between the engraved dimensions and the designed dimensions, in this case, only the adjustment of this parameter rather than the minute changes of the motion resolution will influence the engraved dimensions.

This parameter is invalid when the equipment is not provided with the closed-loop detection system. In this case, the minute changes of the motion resolution will directly influence the engraved dimensions.

Most Speed (mm/s): The max. speed allowed for single-axis movement. This value decides the max. Engraving speed and cutting speed.

Stop Speed (mm/s): The speed of sudden stop during single-axis motion, i.e., the motion stops speed.

If the stop speed is high, the equipment will get greater impact when stopping and starting; the effect of engraving will be poor while the engraving efficiency will be high;

Most_Acc(mm/s²): Max acceleration of the axis, the ratio of change of speed. It is the ability of speed change from one value to another value in unit time.

The higher the acceleration, the time of the speed from one variable to another is shorter. And carving efficiency is high, but the impact of the equipment and equipment abrasion is big;

Otherwise, efficiency is low, the impact of equipment and equipment abrasion is small.

The max acceleration must match the max speed. Then device will work in the best state (that is, the equipment work with high speed and carved to obtain the very good effect). In general, the user can set the parameters reasonable according to their requirement for engraving speed and accuracy.

To meet the accuracy requirement of the user, it can improve the speed and acceleration to make engraving efficiency.

If speed is now meet the requirements of users, or it was unable to reach the maximum speed of current Settings, the user can appropriately reduce the speed value. Because each user's environment and engraving requirement is different, so the device's max speed and the max acceleration will also be different. Users can obtain the best parameters after repeated practice.

Max. Space: As either the bean or the guide rail has a fixed length, each machine has a max working breadth (i.e., working range), which limits the motion of the machine within the max working breadth and makes the trolley and the beam move within the working range. The trolley and the beam will not hit the machine edge as there's the limitation of max space.

4.2.3 Embroidery Import

Embroideries Import is provided for the convenience of the user to import DST, DSB files of format, the import of CAD files is opened here. Please see the figure below:

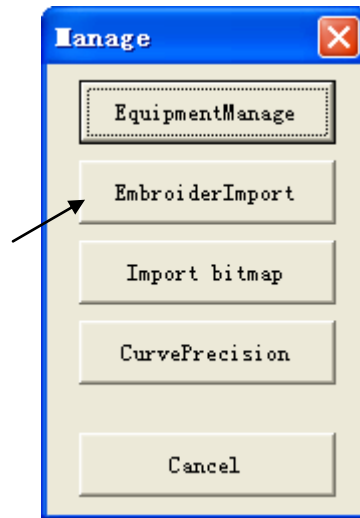

Fig. 4-20

4.2.4 Import Bitmap

If have a bitmap for engraving, click on the import bitmap button in Fig. 4-20, a Import set window will be shown. If you need to change the bitmap into reseau diagram, select the NetMode check box. You can set the direction of net point or the size of point. Click OK button to import the bitmap.

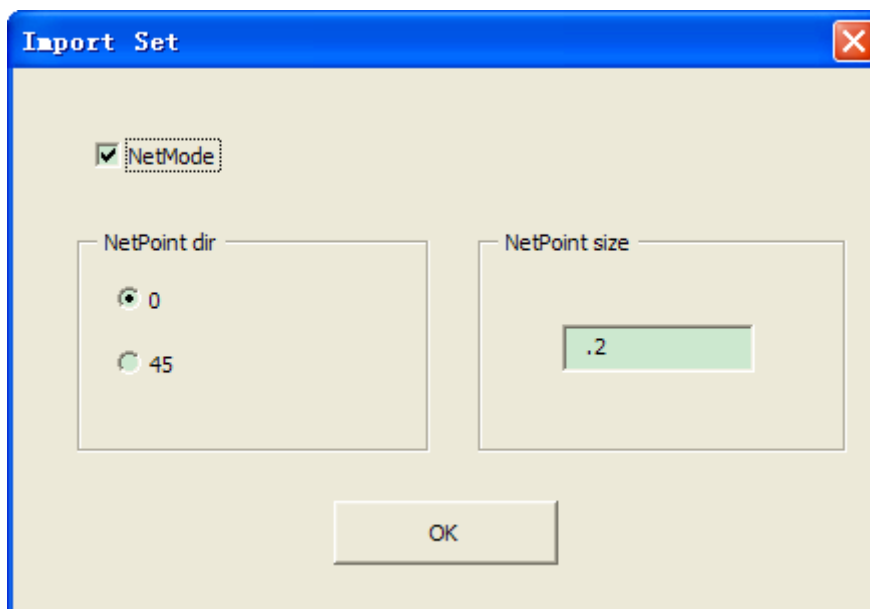

Fig. 4-21

4.2.5 Curve Precision

Set the curve accuracy with the software to improve the smoothness and speed of the operation, you can select general, meddle, high, very high, most high, etc..

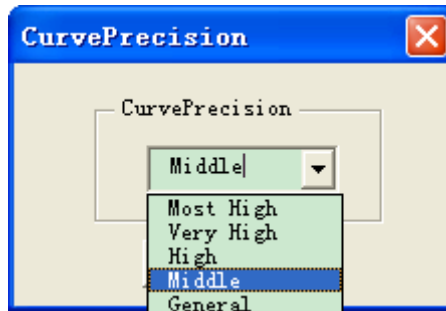

Fig. 4-22

4.3 CAD Direct Output Software Operation

Open the CAD software, show as Fig. 4-23

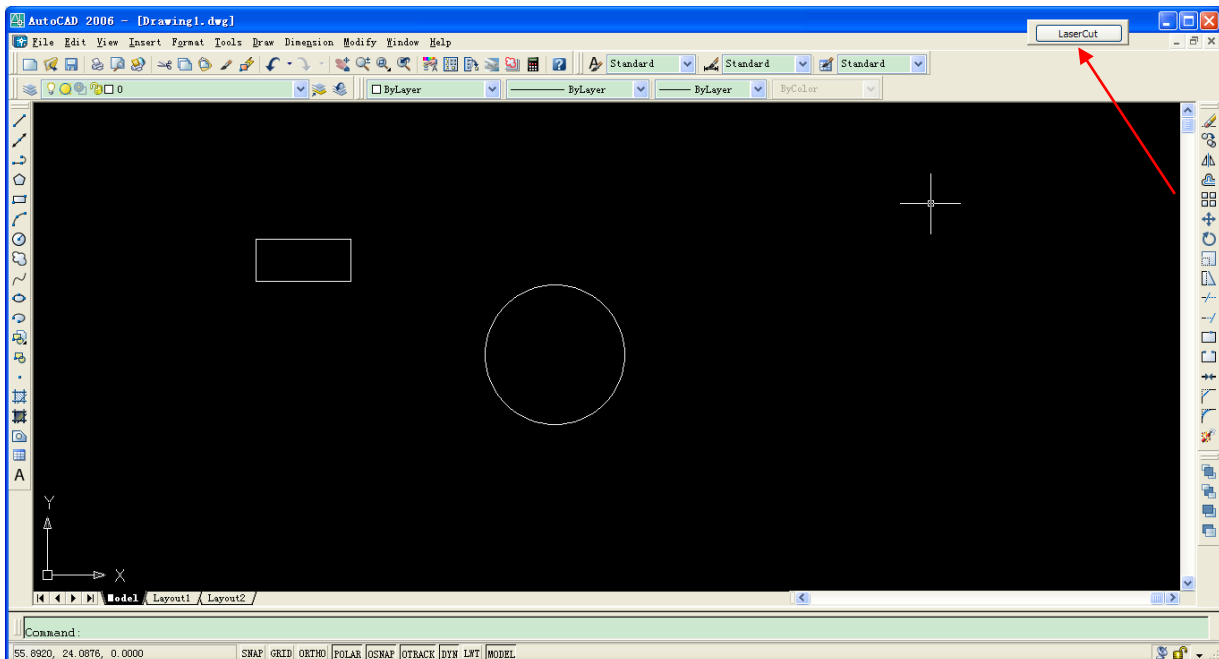

Fig. 4-23

4.4 CAD Direct Output Software Supplementary Description

4.4.1 The Support of AutoCAD Direct Output Annotation Text

Text and annotations in CAD system are normally exported as auxiliary information, therefore, in usual cases, you need not select text and annotations in the window shown in Fig. 4-24. However, in special cases, e.g., the user needs to engrave the text in the graphics, and even the annotations, for output, you can select corresponding options in the window shown in Fig. 4-24.

First, you'd like to announce that we do not support text and annotations to a fractional, however, there are some limitations, for example, we support 5, 6 types of large fonts, settings for large fonts are as follows: first enter the menu shown in Fig. 4-24, select Text Style in the "Format" menu.

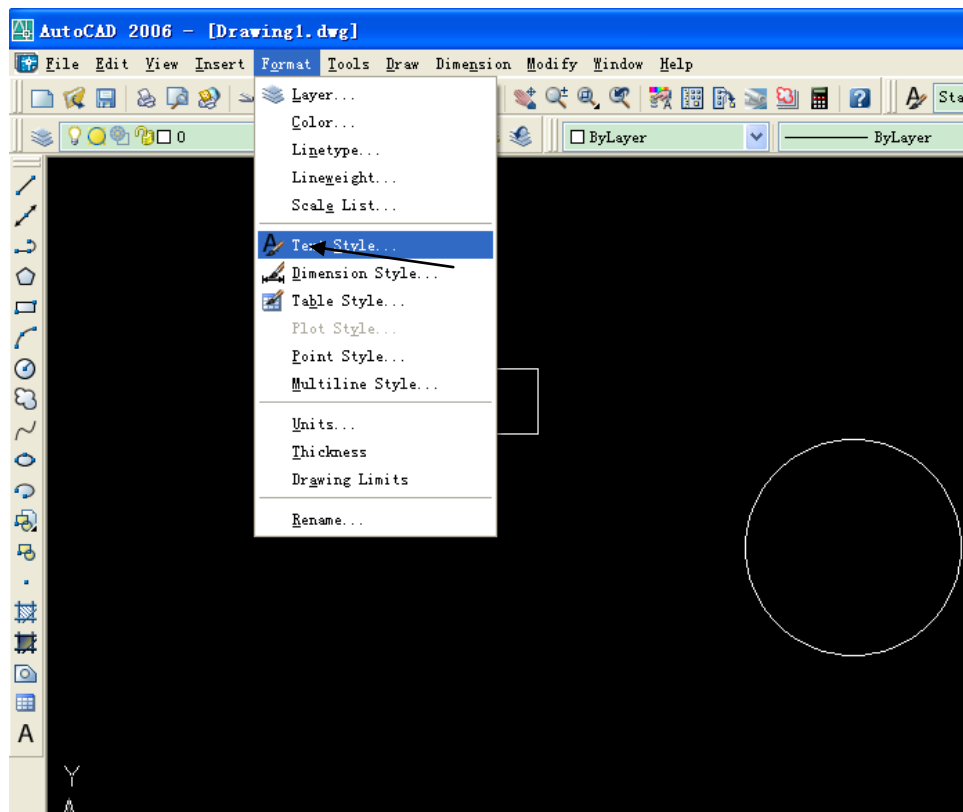

Fig. 4-24

Then you'll enter the menu shown in Figure Fig. 4-25, select Use Big Font (U). And then select the font file you required from the pull-down menu of Big Fonts (B), we currently supports the following font files for Chinese: Fs.shx, gbcbig.shx, HT.shx, Htxt.shx and Khz.shx. So you must select one of the aforesaid files.

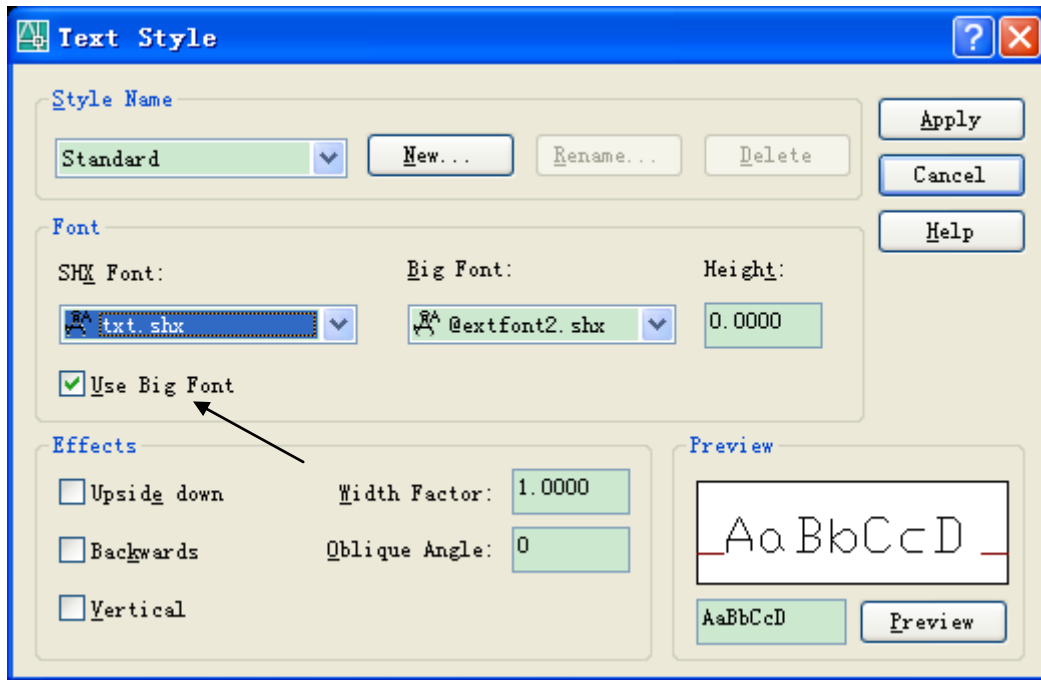

Fig. 4-25

After the steps above, the settings are completed, but please do note that when inputting text, as shown in the figure below, after the text inputting tool is selected, the menu shown in Figure Fig. 4-26 will appear when inputting text.

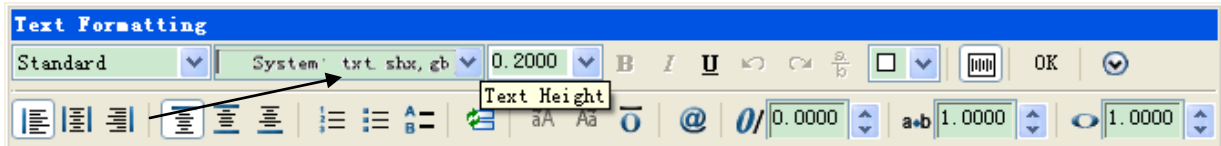

Fig. 4-26

Then you just let it adopt the default font shown in Figure Fig.4-26. Do not select the English fonts or Song typeface or boldface etc. from the pull-down menu, for those may not be supported by our software temporarily. After this, our software can support the engraving output of text in CAD interface.

4.4.2 Carving Gradient Sketch Map

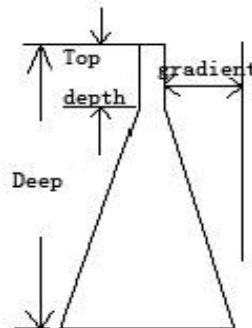

Fig. 4-27

4.4.3 Coordinate System

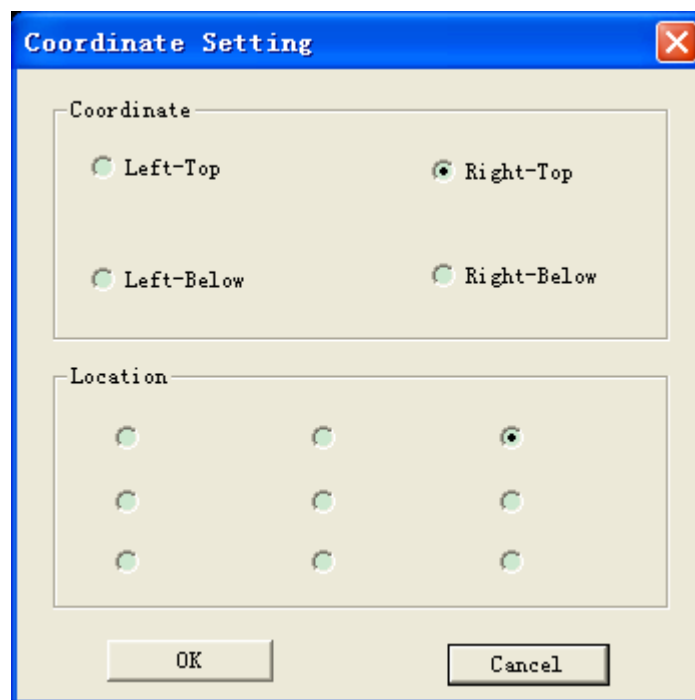

Fig. 4-28

Coordinate: Coordinate must match original position of the machine. On the same machine can't literally change the coordinate system

Location: The position of laser head is the start position before cutting. As shown in figure below, there are 9 locations of laser head relative to the position of graphic. The red cross is the position of laser head.

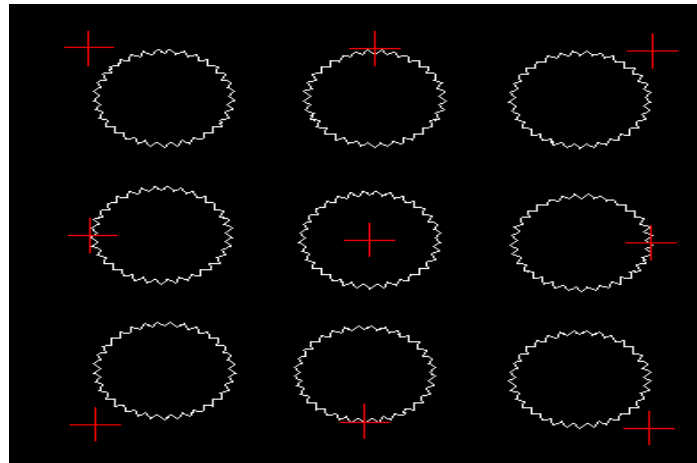

Fig. 4-29

4.4.4 Supplementary Description of Carving

AutoCAD provides the Carving output, which only needs the contour of a drawing instead of filling, which should be particularly paid attention to.

Please note that for drawings drawn in AutoCAD, the Carving in direct output is carried out according to the contour, you need not to draw the drawings in the filled mode, besides, there's no difference between intaglio and incised inscription, Fig.4-30 shows the effects of the origin drawing and the drawing after Carving output, as there's no difference of intaglio and incised inscription in vector graphics, you may get the effect of incised inscription by drawing, please see Fig. 4-31 if there's relation of inclusion between two outline drawings in the same color, the effect shown in the drawing below will be created. If multiple layers of drawings in the same color are included, the effect will be as follows, its rule of Carving output is that: engraving the first layer, not engraving the next layer, and then engraving the further next layer, and the rest may be deduced by analogy. Please see Fig. 4-32

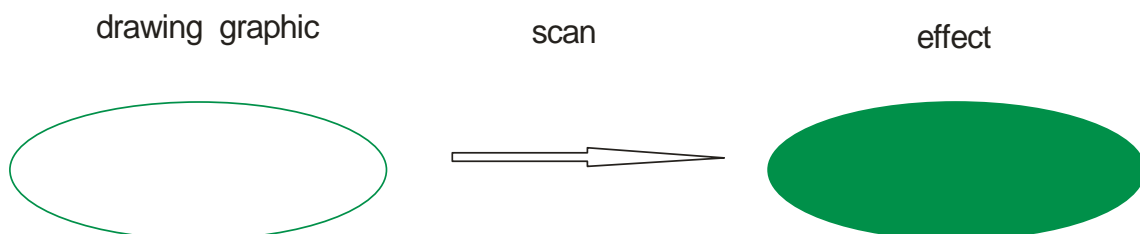

Fig. 4-30

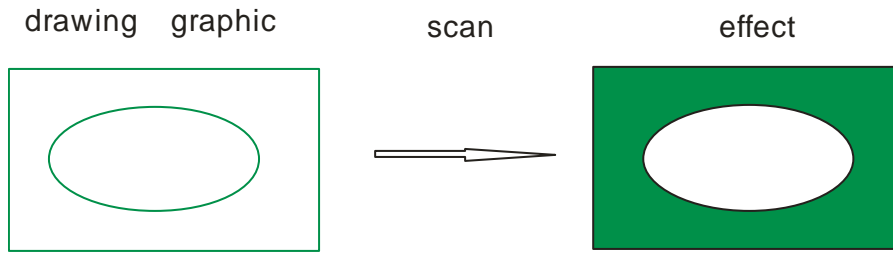

Fig. 4-31

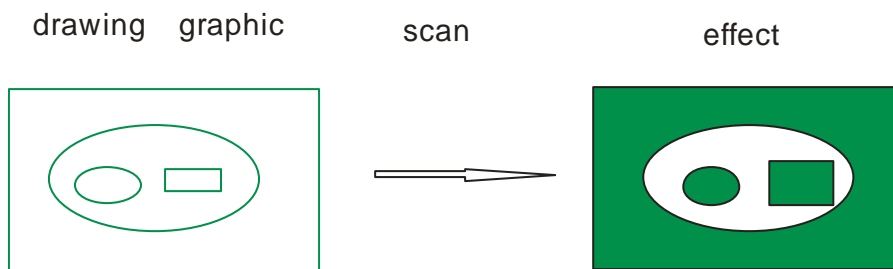

Fig. 4-32

From what described above, we may see that for Carving out of vector graphics, filling is not needed, and there'll not be this kind of influence between drawings in different colors, as shown in Figure Fig. 4-33 drawings in different colors are in the relation of inclusion, no influence on each other. There's overlay between the two parts of Carvings. We believe you may have deeper understanding for the Carving modes of AutoCAD.

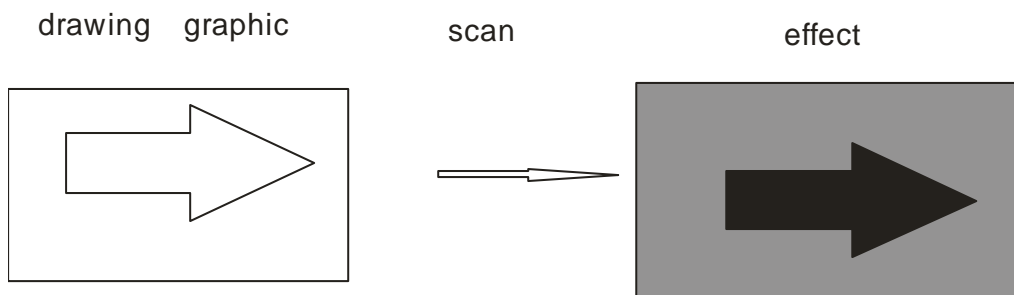

Fig. 4-33

4.4.5 Supplementary Description of Software and CAD Direct Output

Announcement: This document is mainly purposed to provide some methods of analysis and solutions for the disorder of the engraving for vector graphics, as the applications are diversified, some problems cannot be completely solved by our

software alone, Therefore, sometimes the user need to make improvements for the drawing so as to make the operation of the machine in accordance with our ideas.

Some simple drawings may be connected and exported in order

See the figure below:



Fig. 4-34

In Fig. 4-34, we first draw the curve at the center from the left to the right, then draw the line section on the right from right to left, finally, we draw the line section on the left from left to right, according to the original output processing, the result will be as follows.

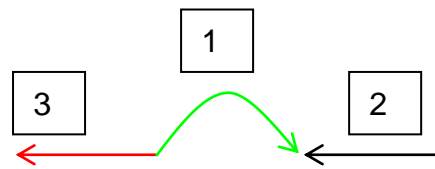

Fig. 4-35

And the order of output by the equipment follows the numbers displayed in Fig. 4-35 the direction for each step of output is shown by the arrow. This effect is poor as its not completed from the beginning to the end b one run.

There are 2 ways to solve this problem, 1: draw the drawings in order or combine them with the merger operation provided in software like CorelDRAW or AutoCAD etc., 2: our software engraving can change the order into a smooth and continuous way of operating from the beginning to the end when processing the drawings.

The current software has make processing to drawings as shown in Figure 1 to make them to be exported from the beginning to the end, i.e., this problem of output order has been solved in the latest version of the software. However, we recommend our users to draw the drawings in order when using AutoCAD or CorelDRAW etc., if you fail to do that, you can combine them together with the merger operation provided in the aforesaid software, which may provide higher fault tolerance.

Normalized output for complicated drawings are shown in Fig.4-36 below

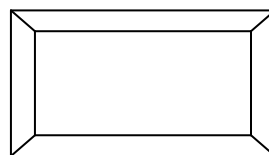

Fig. 4-36

Fig.4-36 is not so complicated, however, according to our observation, many users will

draw the figure in several sections instead of drawing it continuously, therefore, the software will create multiple effects of output (this is relevant to the order of drawing of different users), however, may be none of the effects is what you expect.

Please see the following sample for different effects of cutting.

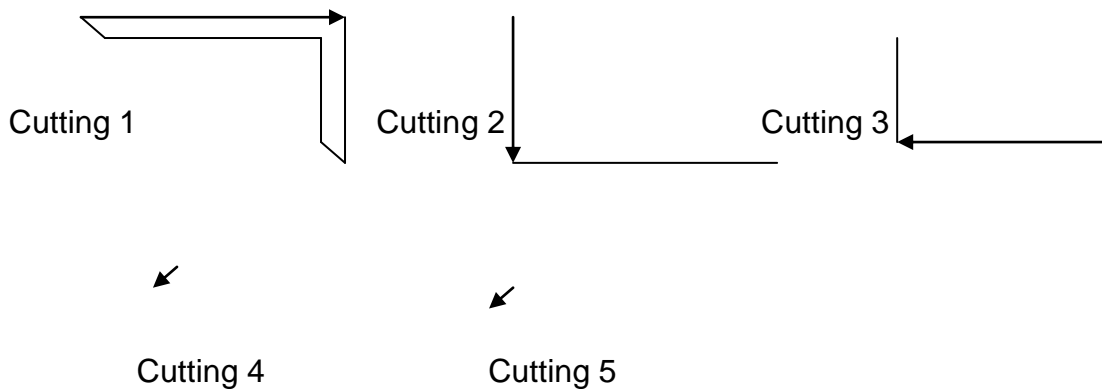

Fig. 4-37

As you can see in the drawings above, it totally takes 5 times to cut the entire drawing, and the procedure is disordered. The effect is not expected, seeing from the stroking in the drawings above, each Outline reaches the end and stops till there's no connected line section, but it is hard to choice the path in this way, and there's also great randomness, therefore, the entire drawing is divided into several parts. There's little software, currently, is provided with the capacity to manage the problems as a whole like human being, for instance, cutting the external rectangle before the internal part etc.. Therefore, we must pay attention to this kind of drawing when drawing, e.g., if you want to cut the two rectangles along the 4 sides, you must combine the separate line sections of the rectangles together with software, thus the disordered engraving will be avoided and a relatively neat path will be achieved. Many users just patch up the drawings Outline by Outline in irregular order, therefore, multiple types of stroking will be created for a drawing as shown in Fig.4-34, which is actually very simple, while in fact, there are many drawings much more complicated than this one, one joint may be connected with many line sections, and the stroking will be more disordered, so it's hard to arrange the order effectively by our software alone, and you must solve the problem from the beginning, the method of drawing.

Disordered output for single lines without joint or crossing

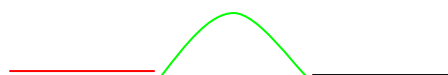

Fig. 4-38

Fig. 4-38 seems to the same to Fig. 4-34 at first view; however, the engraving is disordered, why? Let's amplify the drawing and you can see that there's no joint

between the line sections, so the order cannot be arranged. Therefore, when drawing, pay attention that the joints must be closed.

No display when opening the drawing in a 3rd party engraving software, or run into a wall when using CAD for direct output.

For example, you draw a drawing in CAD, which looks normal, while it cannot be displayed in a 3rd party engraving software, or run into a wall when exported to the equipment. Why? This is normally caused by a small drawing or dot far away from the drawing, which is not what the user expects to process but is just drawn by mistake, this makes the whole drawing to be so large and cannot be seen when opened in another software after zooming out, and the breadth of output will be far exceeding the operation breadth of the equipment, which will also cause problems.

Part of the drawings of CAD direct output or in DXF files cannot be displayed and processed

AutoCAD2005 is newly provided with region tools and table tools, parts of a closed drawing can be processed into the drawing of a region via the region tools on the left. Then the software cannot recognize and process it, so pay attention that there should not be any region drawing when drawing, if there are some, they should be redrawn by line sections or curves or be broken up with breakup operation. Tables drawn with the table tools should follow the same way, they can be normally exported after being broken up, those are all new features after AutoCAD2005.

Part 5 Panel Operation

5.1 Panel and Key Instruction

5.1.1 Panel

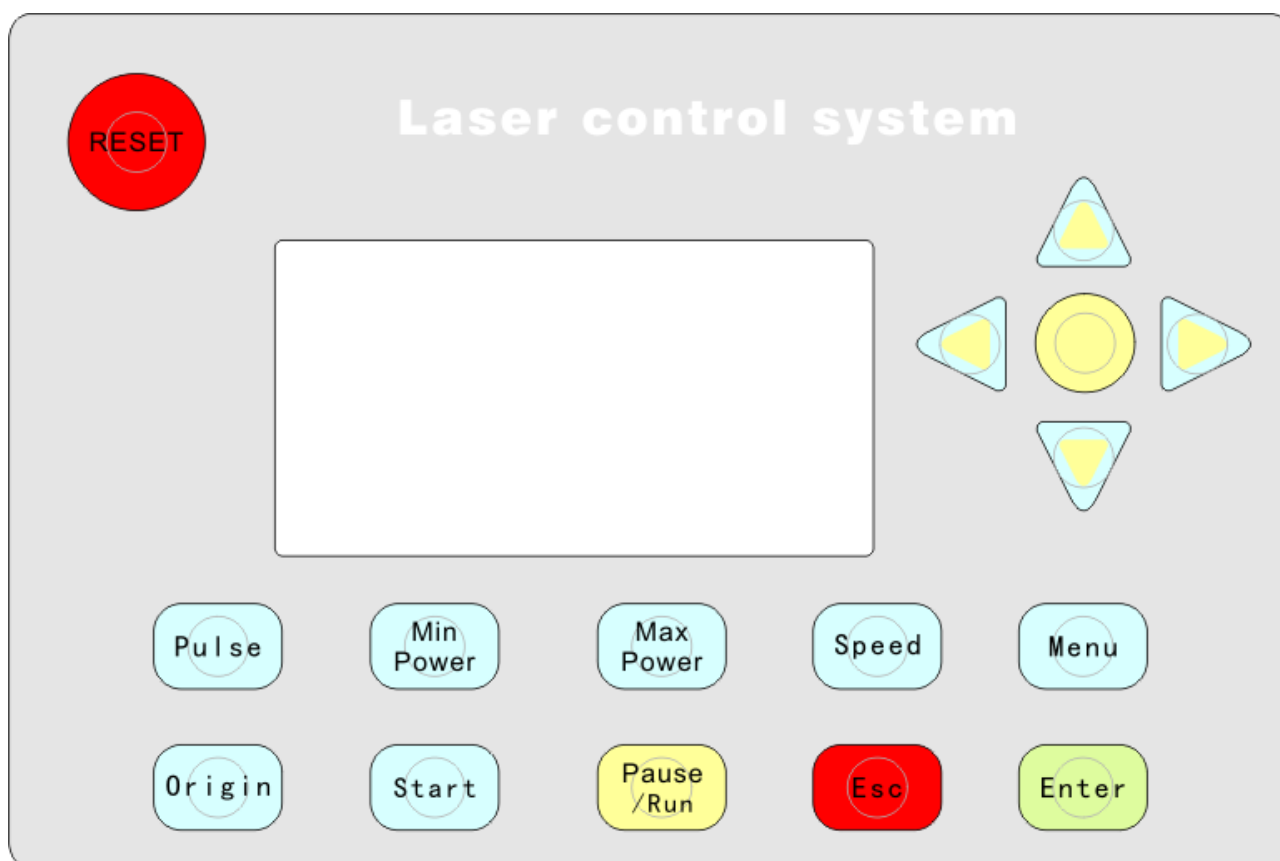







Fig. 5-1

5.1.2 Key



- 1) “Emergency” key: No matter what status the machine is in, when you press this key, the machine will go to the reset status and then return to the preset “Origin”.

- 2)  “Menu” key: When you press this key, the system will go to the main menu.
- 3)  “Esc” key: As a definition key, this key is used to cancel the operation and return to the previous interface.
- 4)  “Pulse” key: This key is used for testing. It flashes every time that you press. It is used to test the optical path adjustment.
- 5)  “Enter” key: As a definition key, this key is used to confirm the current operation.
- 6)  “Speed” key: This key is used to set the working speed. For the value setting, refer to “Value setting” section.



01: Work Speed
02: Idle Speed
03: Range Speed
04: Speed Factor

Fig. 5-2

- Work Speed: It shows the system default speed value. The unit is mm/s.
- Idle Speed: The speed of axis moves without laser on. It shows the system default speed value. The unit is mm/s.
- Speed Factor: It is applied to improve the smoothness of movement. The range is 0.00-5.00. The smaller the factor, the slower of planned speed of lines in work file, and then the smoother of movement when turning corner. Normally it is set to 2.5. If the smoothness is high demanded, set the factor to less than 1.

- 7)  “Min Power” key: This key is used to set the minimum laser intensity of

the preset laser.



- 8) "Max Power" key: This key is used to set the maximum laser intensity that the machine responds.



- 9) "Start" key: When you press this key, the system starts running the current file.

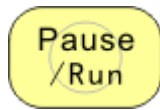

- 10) "Pause/Run" key: This key is used to pause or go on the operation. In the pause status, when the "Origin" key is not pressed, press this key after moving X axis or Y axis to make the system return to the original location automatically.



- 11) "Origin" key: This key is used to set the initial location that the machine runs. "Origin" can be selected in the parameter setting software at your will. If "mechanical origin" is selected, it returns to the machine's mechanical origin after reset. The coordinates is "0, 0". If "home position" is selected, it returns to the current coordinates of the previous operation after reset.

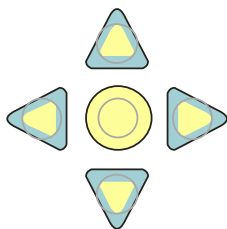

- 12) "Up" "Down" "Left" "Right" keys: In the waiting status, they mean upward, downward, leftward and rightward movement.

5.2 Interface Introduction

5.2.1 Start Up

When the system is powered on, the LCD displays "System Init...".



System Init...

Fig. 5-3

5.2.2 Main Interface

After the initialization, the system goes to the main interface. When no engraving file is selected, it displays:

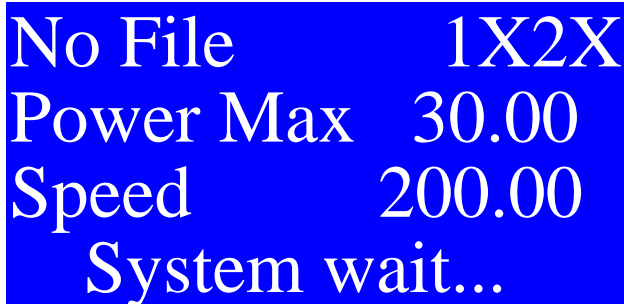

No File 1X2X
Power Max 30.00
Speed 200.00
System wait...

Fig. 5-4

When one engraving file is selected, it displays:

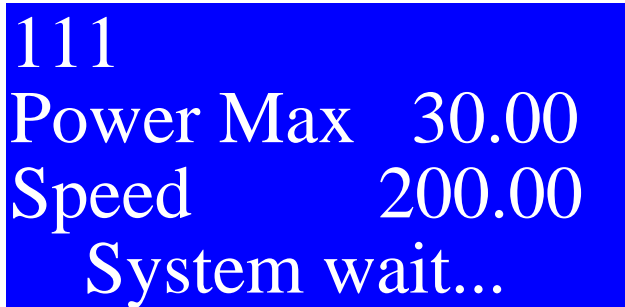

111
Power Max 30.00
Speed 200.00
System wait...

Fig. 5-5

Where, the parameters have the following meanings:

- File name: The top left corner in the first line displays the name of the currently processed file. If not file is selected, it displays “No file”.
- Water protection prompt: The top right corner in the first line displays the water protection 1 and water protection 2 unconnected. If the water protection is enabled,

it is not displayed.

- Max power: It allows setting the percentage of the maximum intensity in the processing file, and displays the intensity of laser 1.
- Engraving speed: It allows setting the percentage of engraving speed in the processing file.

In the waiting status, when you press “” SELECT key in the middle, the system goes to the following interface.



1.Key Speed Midd
2.Run Range No
00:11:20
Work Times: 2

Fig. 5-6

Press Up and Down keys to select parameter 1 or parameter 2 that you want to change. The selected changeable value has shadow at its background.

- Key speed: It means the speed of manual frame movement. You can press “SELECT” key in the middle to change the speed of frame movement. There are three options available: “Fast”, “Normal” and “Slow”.
- Run range: It includes two preview modes. One mode is preview with lighting; and the other mode is preview without lighting. You can press “SELECT” key in the middle to change the two preview modes. Select “Yes” to preview with lighting, and select “No” to preview without lighting. After your selection, press “Enter” to start preview.
- Work Time: Work time of the current file.
- Work Times: The complete number of the current file.

In the standby interface, press “Enter” to go into the Z, U axis moving interface.

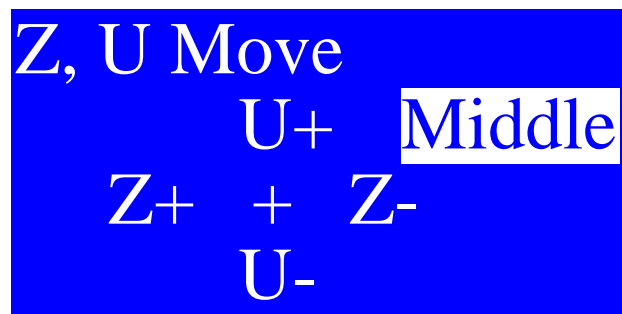

Fig. 5-7

Press “Up”, “Down”, “Left”, “Right” to move axis Z/U. Press “SELECT” to change the speed.

In the main interface, press “Esc” to go into Move X/Y axis interface.



Fig. 5-8

Set the coordinates of X/Y then press “Enter” to move.

Under the work status, the Left bottom of the main interface shows the work time, and the right bottom shows the percentage of work progress



Fig. 5-9

5.2.3 Menu

Press “Menu” key to go to main menu interface:



Fig. 5-10

In this status, press “Min Power” key four times, and then press “Max Power” key four times. Enter the management password, and press “SELECT” key to select whether enable the factory setting. If you enable the factory setting, you can directly modify the factory setting on the panel. If you disable the factory setting, the corresponding factory setting on the panel menu will not appear.



Fig. 5-11

5.2.4 Value setting

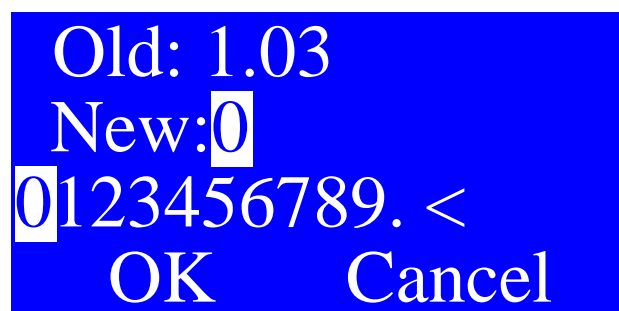





Fig. 5-12

Press “” or “” to select the value. The selected value has shadow at its background. Press “” SELECT key in the middle. In this case, the selected value

is displayed in the second line of the interface. The setting value must be set from higher digits to decimal digits. For example, if the setting value is 5.3, first press

“” or “” to select ‘5’; and then press “” key to select ‘.’; afterwards press

“” key, to select ‘3’, finally press “” key. If you selected “<”, press “”

SELECT key in the middle to delete the currently set value. After your setting, press



“ **Enter** ” to exit the setting interface. If you want to cancel this setting, you can



directly press “ **Esc** ” to exit the setting interface.

5.3 File Manage

Select “File Manage” and press “Enter” key go to the Files management interface.

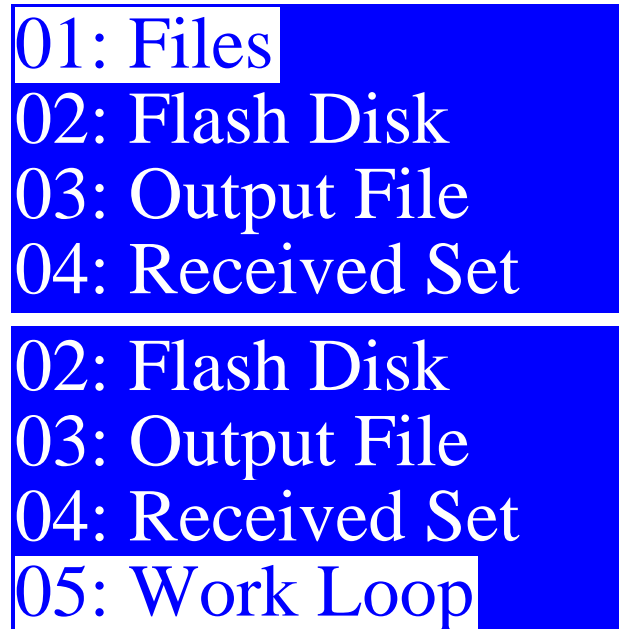
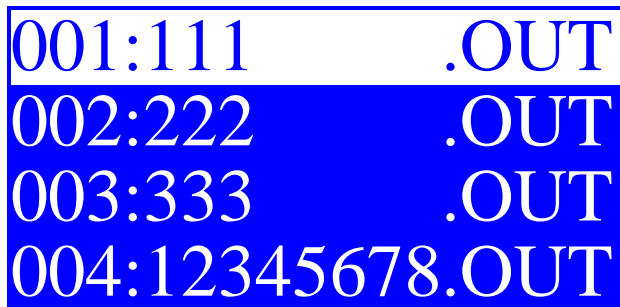

Fig. 5-13

Press “Up” or “Down” to move cursor to select item, press “Enter” to confirm.

5.3.1 Files in Card

In the File Manage interface, select “File” and press “Enter” to view the files saved in controller.



```
001:111 .OUT
002:222 .OUT
003:333 .OUT
004:12345678.OUT
```

Fig.5-14

Press “Up” and “Down” keys to select the file you want to operate, and press “Enter” key to go to the following interface.



```
01: Select File
02: Delete
03: Delete All
    OK      Cancel
```

Fig. 5-15

- Write into memory: To engrave this file.
- Delete: To delete this file.
- Delete all: To delete all files in the memory.

5.3.2 Flash Disk

In the File Manage interface, select “Flash Disk” and press “Enter” to view the files saved in U-Disk.

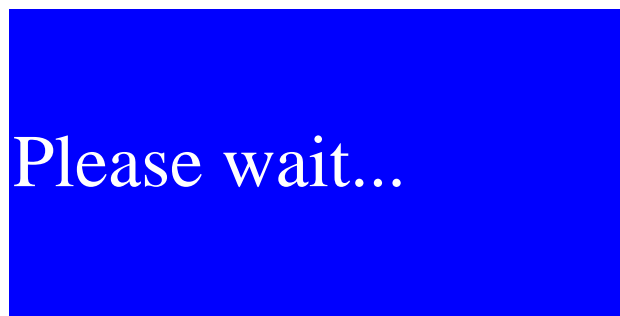

Fig. 5-16

If the U-Disk is working properly. The valid files in U-Disk will be shown.

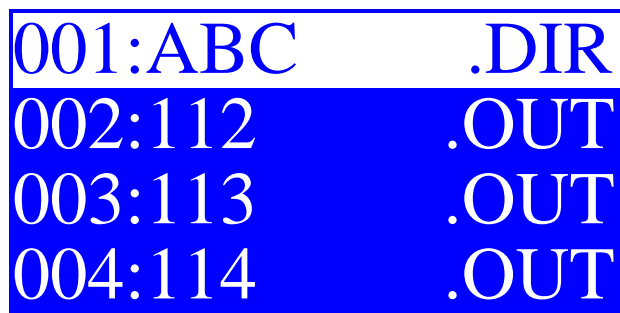

Fig. 5-17

Select one file and press “Enter”.



Fig. 5-18

Press “Enter” to copy the file from U-Disk to the flash in the controller. Then a copying file progress will be shown. When finish, the controller will beep. Press “Esc” to back.

If U-Disk does not insert. Or it is not working properly. The following dialog will be shown.

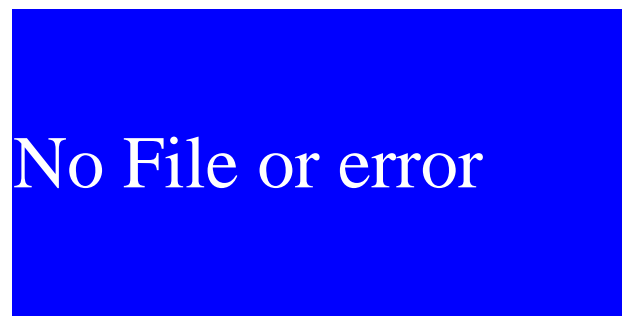

Fig. 5-19

Would you please check whether the U disk is inserted at this time.

5.3.3 Output File

In File Manage interface, select “Output File” and press “Enter” to go to copy file to U-Disk interface.

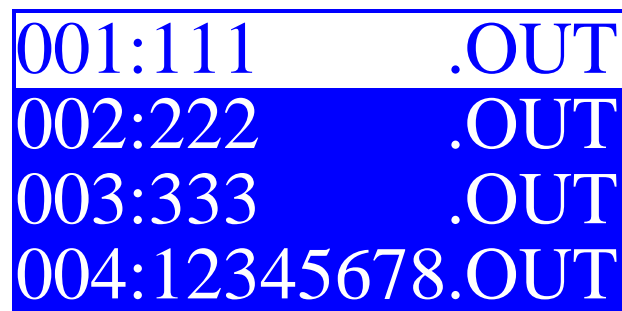

Fig. 5-20

Press “Up” and “Down” to select one file. Press “Enter” to confirm.

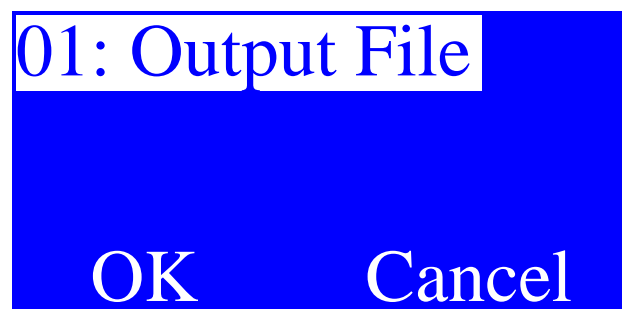

Fig. 5-21

Press “Enter” to copy file to U-Disk, press “Esc” to back.

5.3.4 File Receiving Setting

Select “Received Set” and press “Enter” key go to the file receiving setting interface. The file receiving setting only changes the setting of uploading the file to the system from the computer. Press “SELECT” to change the setting modes. The file receiving modes have three options: Receive Select, Receive Temp., Normal.



Fig. 5-22

- Receive Select: The received file becomes the currently working file automatically, namely after the receiving operation, press “Start” to start engraving the current file.
- Receive Temp.: The received file will overlap the last file displayed in the Files completely.
- Normal: Like the file copied from the flash disk, the received file is displayed as the last file in the Files.

5.3.5 Work Loop

Press “Enter” to go into the work loop setting interface. Press “SELECT” to modify.

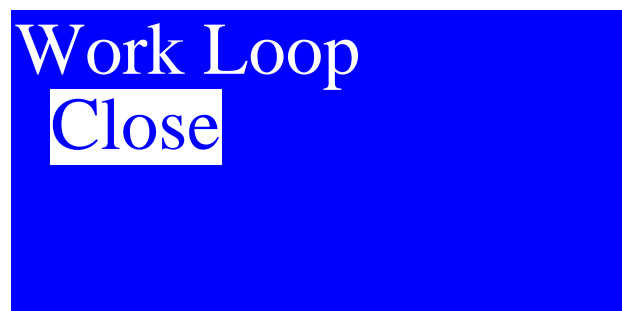

Fig. 5-23

If it set as “Open”, the file in the flash will be processed one by one. It means when one work is finished. Press “Start” button, the second following file will be selected and processed.

5.4 Equipment Type



Fig. 5-24

Press “SELECT” to modify the equipment type: Common Type, Round Equipment. When select the Round Equipment, press “Enter” to set the Diameter and the Circle Pulse.

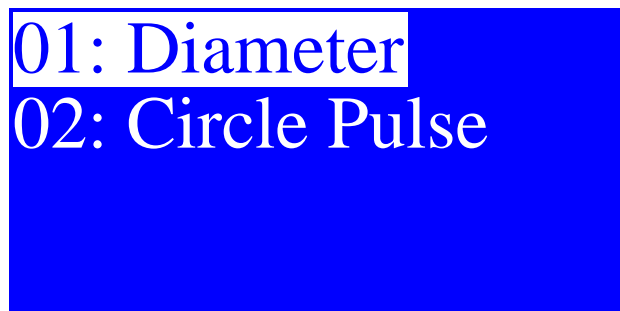

Fig. 5-25

- Diameter: Work piece diameter.
- Circle pulse: Subdivision*Transmission ration.

(**Note: Axis Y precision=(3.1415926*1000*Work Piece diameter(mm))/Circle pulse**)

5.5 Axis Move



1. X:	100.000
2. Y:	200.000
3. Z:	0.000
4. U:	250.000

Fig. 5-26

Press “Up” and “Down” keys to select the axis, and press “Left” and “Right” keys to move the axis. When it stops, the values display the current coordinates. In the joggle mode, press “Left” and “Right” keys to move the axis. The distance every time you press the key is that you set in the joggle mode.

When you press “SELECT” key, it displays the following interface:



1.if light?	No
2.Key Speed	Midd

Fig. 5-27

Press Down key to select parameter 1 or parameter 2 that you want to change. The selected changeable value has shadow at its background.

- If lighting: The single axis moves in two modes: One is movement with lighting; the other one is movement without lighting. You can press “SELECT” key in the middle to change the two methods. Select “Yes” to move with lighting, and select “No” to move without lighting. After your selection, press “Enter” key.
- Key Speed: It means the speed of manual axis movement. You can press “SELECT” key in the middle to change the axis movement speed: “Fast”, “Normal” and “Low”.

Part 6 Assistant function

When the system is powered on, press “Menu” to enter main menu interface then select “Assistant” and press “Enter”. It is shown as:

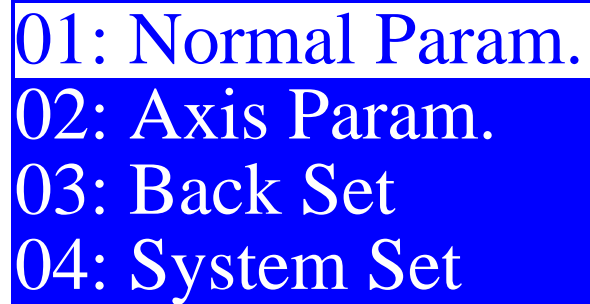

01: Normal Param.
02: Axis Param.
03: Back Set
04: System Set

Fig. 6-1

Press “Up” and “Down” key to select the item and press “Enter” to confirm.

6.1 Normal Parameter

In the assistant interface, select the “Normal Parameter” and press “Enter” to go into the normal parameter setting interface.

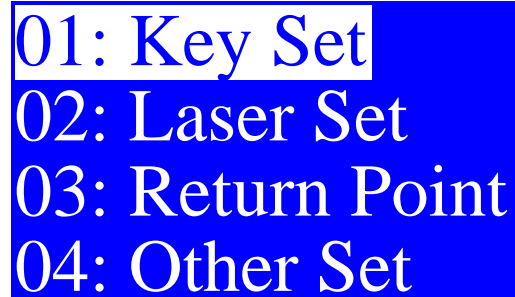

01: Key Set
02: Laser Set
03: Return Point
04: Other Set

Fig. 6-2

Press “Right” to page down:



05: Cover Set
06: Light Delay
07: Time Set
08: Equipment No.

Fig. 6-3

Press "Right" to page down:



09: Password Set
10: Preview Set
11: Lang(语言)
12: Laser Time

Fig. 6-4

Press "Right" to page down:

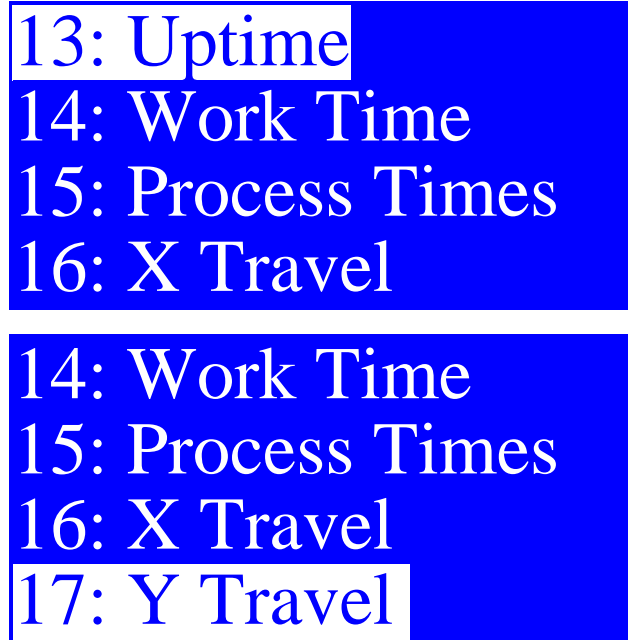

13: Uptime
14: Work Time
15: Process Times
16: X Travel
14: Work Time
15: Process Times
16: X Travel
17: Y Travel

Fig. 6-5

6.1.1 Key Set

Select the "Key Set" and press "Enter".



01: Seri. Mode
02: Jump Step
03: Key Dir

Fig. 6-6

- If the cursor selects “Seri. Mode”, press “Enter” key to go to the continuous mode setting interface. Press “SELECT” key to change the setting. The continuous mode setting only has two options: Open and Close.
- If the cursor selects “Jump Step”, press “Enter” key to go to the joggle mode setting interface. It can set the distance that the axis moves every time you press the axis movement key. $0 \leq \text{distance value} \leq 100$, in mm.
- If the cursor selects “Key Dir”, press “Enter” key to go to the key polarity setting interface. The panel’s direction keys correspond to the axis movement directions. If you press Left key, but it moves rightwards, you only need to change the polarity and then press “SELECT” key.

6.1.2 Laser Set

Select “Laser Set”, press “Enter” to go in laser setting interface.

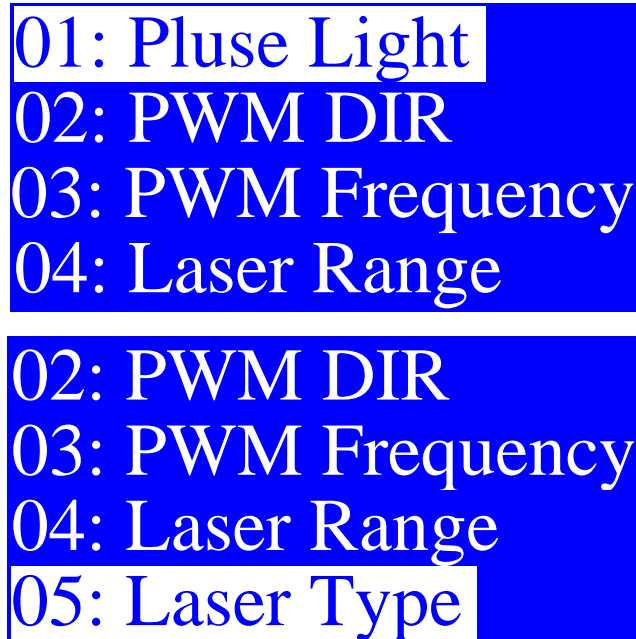

Fig. 6-7

- If the cursor selects “Pulse Light”, press “Enter” key to go to the pulse light setting and display the value setting interface. Here, you can set the pulse lighting time. When you press “Pulse” key for a long time, the time is the pulse lighting time, in S.
- If the cursor selects “PWM DIR”, press “Enter” key to go to the PWM polarity setting. If you find that the actual the lighting intensity increases when the intensity becomes lower. You only need to press “SELECT” key to change the PWM polarity, and then press “Enter” key.

- If the cursor select ““PWM frequency”, press “Enter” key to go to the PWM frequency setting and display the value setting interface. Here, you can set PWM frequency.
- If the cursor selects “Laser Range”, press “Enter” key to go to the duty ratio setting interface, set the maximum/minimum duty ratio, and display the value setting interface. Here, you can set the duty ratio. Duty ratio setting range: $0 \leq \text{minimum duty ratio} \leq \text{maximum duty ratio} \leq 100$. If the maximum duty ratio is equal to the minimum duty ratio, the intensity can't be adjusted.
- If the cursor selects “Laser Type”, press “Enter” key to go to the laser typesetting interface and display value setting interface. Here, you can set the laser type. 0 for CO2, 8 for RF1, 16 for RF2. RF1 is for RF laser without pre-ionize. RF2 is for RF laser with pre-ionize that will output 1us tickle pulse.

6.1.3 Return Point

Select the “Return Point”, press “Enter” to go to the go back position after working setting interface.



Fig. 6-8

Press “SELECT” to modify: Machine Origin, No, Orientation

Return Point means the location where the laser head finally stays after the equipment operation or the reset operation.

- Mechanical origin: After the equipment operation or the reset operation, the laser head stays in the mechanical origin.
- No: After the equipment operation, the laser head stays in the last location after the operation.
- Orientation: After the equipment operation or the reset operation, the laser head stays in the user newly defined locating point.

If the mechanical origin coincides with the orientation, the two options are equivalent. The user can make selection based on his/her own habit.

6.1.4 Other Set

Select the “Other Set”, press “Enter” to go into setting interface.

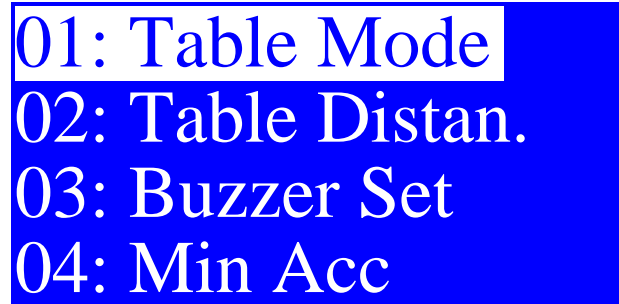

Fig. 6-9

- Table Mode: Common Mode, Double Table. Press "SELECT" to modify.
- Table Distance: if select Double Table, it needs to set the distance between the two work table. The distance subjects to the two upper left corner of table model.
- Buzzer Set: Set the Beeping times after working.
- Min Acc: The min acceleration for start moving or stop moving. The less this value, the smoother the movement, the longer the working time. Normally, it is set to 400mm/s². If a shorter work time is required, set the value no less than 850 mm/s² (According to the actual machine to set this value).

6.1.5 Cover Set

Select “Cover Set”, press “Enter” to go to modify.



Fig. 6-10

If the setting interface displays “Open”, it means that it is in enable mode now. If the setting interface displays “Close”, it means it is in disable mode now. When the cover protect mode is enable. If the cover protect input is active, the work will be pause.

6.1.6 Light Delay

Select “Light Delay”, press “Enter” to go into light delay setting interface.

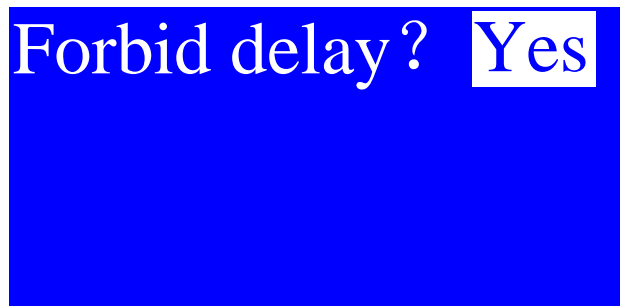

Fig. 6-11

If Forbid delay is “Yes”, the parameters of laser on or off delay in the file will be disabled. Otherwise select “No”.

6.1.7 Time Set

Select “Time Set”, press “Enter” to go into time setting interface.

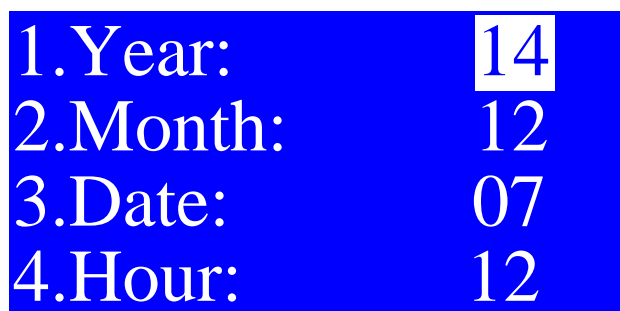

Fig. 6-12

Press “Up” and “Down” keys to select the item to be set. When the cursor is in “Hour”, press “Down” key to display the following interface:

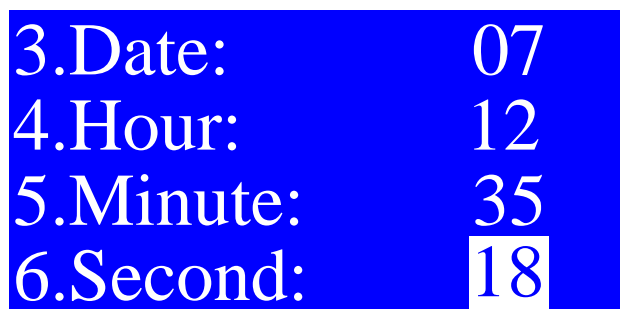

Fig. 6-13

To set year, month and date, press “Up” and “Down” buttons. When the cursor in any option, press “Enter” button set the value.

Note: For the time setting, equipment number and password setting, management password is required. After the password is entered correctly, press “Enter” to go to the setting interface.

6.1.8 Equipment Number

Select “Equipment No.”, press “Enter” to go into equipment number setting interface.

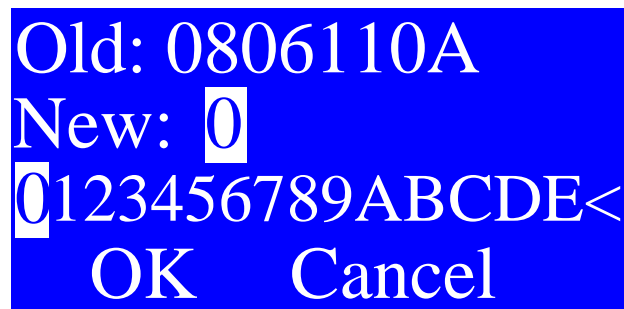

Fig. 6-14

Input the machine number, and press “Enter” to set. Or press “Esc” to back.

6.1.9 Password Set

Select “Password Set”, press “Enter” to go into management password and machine lock setting interface.

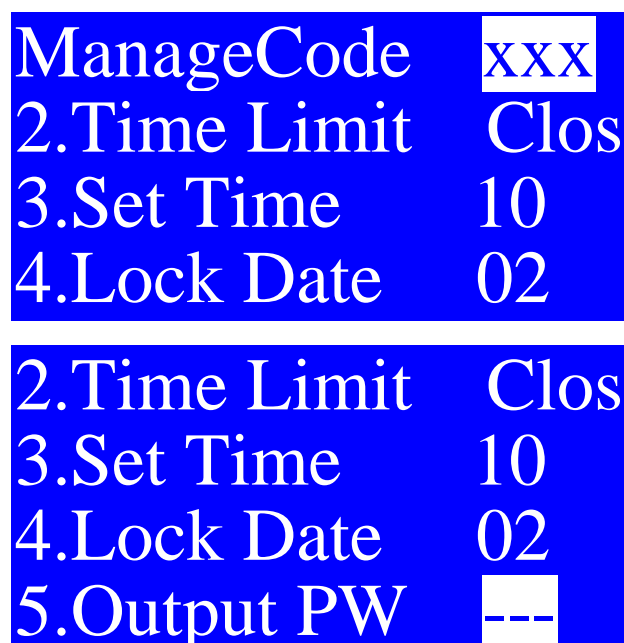

Fig. 6-15

Press “Up” and ”Down” to select item. Press “Enter” to set.

- If the cursor selects “Manage code”, press “Enter” key to go to the management password setting interface. The management password must be 8 numbers.
- If the cursor selects “Time limit”, press “SELECT” key to select to disable or enable the option, namely whether the encryption is effective.
- If the cursor selects “Set Times”, press “Enter” key to go to the password times setting. Here, you can set password times (setting range: 0~30).
- If the cursor selects “Lock Date”, press “Enter” key to go to the lock date setting. The lock date is encrypted starting time. **Setting range: 1~28 days.**
- If the cursor selects “Out Password”, when the flash disk is inserted, press “Enter” key to export the password text file.

Note: This system can encrypt the hardware by phases. The phase number (password times) is 30 at most. The time of each phase is one month. The password is exported and saved in the flash disk.

6.1.10 Unlock Machine Password Preview

Select “Preview Set”, press “Enter” to preview the unlock machine password if the ”Time Limit” is Open.

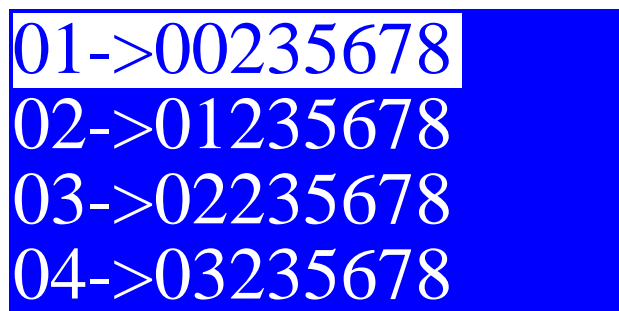

```
01->00235678
02->01235678
03->02235678
04->03235678
```

Fig. 6-16

6.1.11 Language

Select ”Lang(语言)”, press “Enter” to select language.



Fig. 6-17

There are three languages: Simplified Chinese, Japanese and English. Press “SELECT” key, and then press “Enter” key.

6.1.12 Laser Time

Select “Laser Time”, press “Enter” to check the laser on time. Press “Esc” to back. Press “SELECT” to clear the parameter. It is the same as follow.



Fig. 6-18

6.1.13 Uptime

Select ‘Uptime’, press “Enter” to check the time of machine after power on. Press “Esc” to back.



图 6-19

6.1.14 Work Time

Select 'Work Time', press "Enter" to check the total process time of machine. Press "Esc" to back.



Fig. 6-20

6.1.15 Process Times

Select "Process Times", press "Enter" to check the total process times of machine. Press "Esc" to back.



Fig. 6-21

6.1.16 X Travel

Select "X Travel", press "Enter" to check the total distances axis X has moved. Press "Esc" to back.



Fig. 6-22

6.1.17 Y Travel

Select "Y Travel", press "Enter" to check the total distances axis Y has moved. Press "Esc" to back.



Fig. 6-23

6.2 Axis Parameter Setting

In the assistant function setting interface, select "Axis Param." and press "Enter" to set the axis parameter.



Fig. 6-24

Press "Up" and "Down" to select the axis, and press "Enter" to set.

6.2.1 Axis Parameter

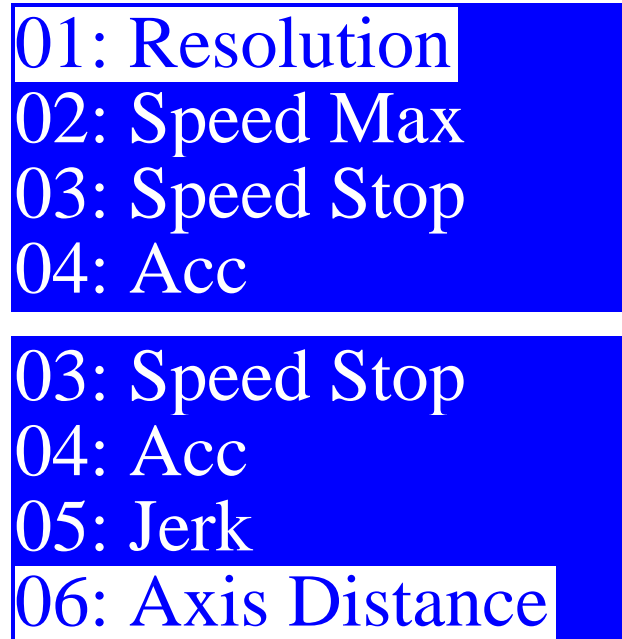

Fig. 6-25

- **Resolution:** the resolution = the length that the laser head moving when the motor rotate a cycle $\times 1000$ / the pulses that the driver output when the motor rotate a cycle.
- **Speed Max:** The maximum speed allowed for single-axis movement. This value decides the max. Engraving speed and cutting speed.
- **Speed Stop:** The speed of start or stop during single-axis motion, i.e., the motion stops speed.
- **Acc:** The Max acceleration of this axis, the bigger the acceleration, the shorter the work time, and the stronger jitter of motion.
- **Jerk:** The acceleration of the acceleration change from the minimum acceleration to upgrade to the maximum acceleration—Or the changed from the maximum acceleration reduce to minimum acceleration during slowdown..The smaller the jerk, the weaker the jitter of motion, the slower of acceleration and deceleration. Otherwise, the jitter is stronger, the accelerating and decelerating is the faster.
- **Axis Distance:** Maximum distance for axis can move.

6.2.2 Resolution

Select “Resolution” and press ”Enter” to set resolution. There are two way to calculate. Input the value directly.

Calculate the resolution from input the actual length (RealSize) and the design length (WishSize).

In the Resolution Setting interface, press “Menu” to set RealSize and the WishSize parameter.

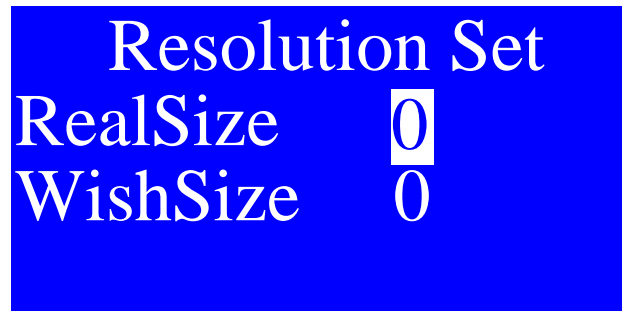

Fig. 6-26

Press “Up” or ”Down” to select the item, press ”SELECT” to set the parameter. When finish input the value of RealSize and WishSize, press “Enter” to calculate the resolution automatically.

About measurement:

Draw a 30*30 rectangle to calculate the resolution. When measuring, the width of the laser beam needs to be considered. The processed rectangle is as shown in figure below. Take the measured value of the X axis 34mm, and input 34 into the Want Size edit box and 30 into the Want Size edit box. Click ok the program will calculate out the right resolution. Other Axis is similar. When calculate the resolution of Y, the Real Size is the length of trace the beam moved.

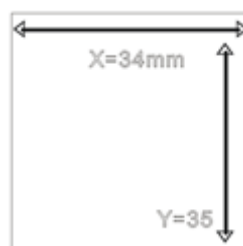

Fig. 5-20

6.2.3 Other Axis Parameters Setting

Select Speed Max, Speed Stop, Acc, Jerk or Axis Distance, and press “Enter”. It will display the value setting interface. According to their respective parameter meaning set each parameter value.

6.3 Back Set

In the assistant function setting interface, select “Back Set” and press “Enter” to set the Homing setting.

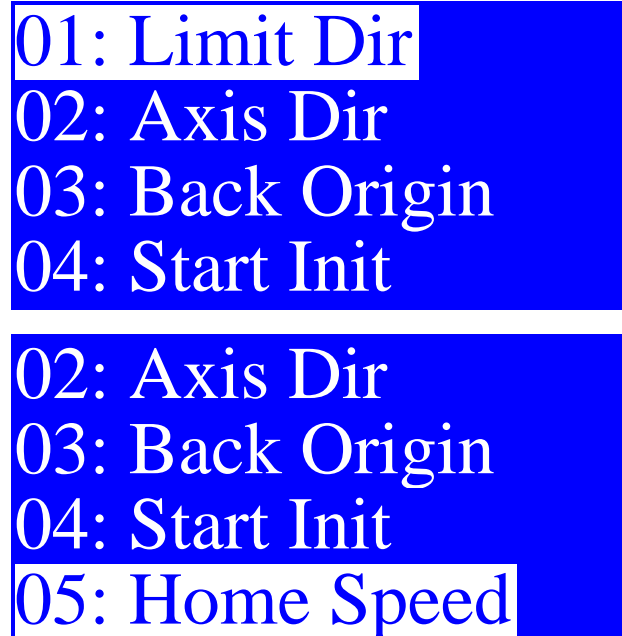

Fig. 6-28

Press “Up” or “Down” to select item. Press “Enter” to set.

- Limit Dir: Limit Polarity (positive and negative). When the limit polarity is positive, the limit signal’s high level is effective. When the limit polarity is negative, the limit signal’s low level is effective.
- Axis Di: Direction polarity (positive and negative): When the axis moves reversely, you can resolve this problem by changing this axis’ direction polarity.
- Back Origin You can select any axis to return to the origin, and other axes don’t move.
- Start Init: You can set the four axes individually. If this axis is set as enable status, the axis returns to the origin automatically when the circuit board is powered on, otherwise, it stays in the current location. The machine takes the current point as machine origin by default.
- Home Speed (mm/s): The homing speed.

6.4 System Setting

In the assistant function setting interface, select “System Set” and press “Enter” to set

the system setting.



01: System Test
02: Version
03: System Update

Fig. 6-29

Press “Enter” to go to system test function. In the first time, it will show an “Input password” dialog.



Input password

Fig. 6-30

Note: Press the “Min Power” button 4 times, then press “Max Power” button 4 times to go in.

- System Test: testing the circuit board’s IO, only used for factory testing.
- Version: Display the current DSP software version.
- System update: When flash disk is used to update the current DSP software, copy the file with flash disk before the update operation. The memory file will be deleted in the update process.

Part 7 The Frequently Asked Question Help

7.1 Power-on Reset Question

Q: the system does not reset, buttons no response, and LCD no display.

A: the system reset error, the solution is:

First, click the “Emergency Stop” on the panel, and check the button normal.

Second, check the external 5V and internal 5V are within the normal.

Q: opening, the X, Y axis not move, the LCD display the main interface, can manual move the axis.

A: the power back to origin error. Into the “Power back to Origin” interface, set the X, Y axis as Opening.

Q: opening, the X, Y axis returns the origin, the LCD still shows “system initialization”.

A: the power back to origin error. Into the “Power back to Origin” interface, set the Z, U axis as Close.

Q: opening, X, Y slow-move a short distance, not reach to the limit point, and complete the reset.

A: the Limit Polarity error. Into the “Limit Polarity” interface, change the X, Y polarity.

Q: opening X, Y move to the opposite direction of limit switch,

A: the direction polarity error. Into the “Direction Polarity” interface, change the X, Y polarity.

Q: button moving, X, Y moving direction is opposite to the button moving.

A: the button polarity error. Into the “Button Polarity” interface, change the X, Y polarity.

Q: after the completion of reset, X, Y fast automatically moving.

A: the regression point setting error. Into the “Regression Point Setting” interface, set the regression point as mechanism origin point.

Q: the setting of power back to origin is close, after power, X, Y still automatically moving.

A: the regression point setting error. Into the “Regression Point Setting” interface, set the regression point as mechanism origin point.

7.2 The Laser Light Question

Q: Long light after power on.

A: view the enable signal of laser power is wiring, and see the jumpers of interface broad DIR3 and DIR4, check whether they e keep the consistency.

Q: When the light power intensity is big, the idemitsu is small; when the light power intensity is small, the idemitsu is big.

A: the PWM polarity setting error, into the button polarity setting interface, changes the PWM polarity.

Q: PWM frequency is correct, light power intensity can be changed by line within 10% - 60%.

A: check the laser power supply model, it's 5.5 voltage, not 3.3V.

Q: Water protection invalid.

A: check the laser type, there are 3 types: 0 is CO₂ glass tube; 8 is coherent glass tube; 16 is RF tube. If the laser type is correct, please check the water protection directly shorted.

7.3 The PC Connection Question

The Questions:

- Reading the parameters, can't open the port.

- Can't read the parameters.
- Transfer the file invalid.

The Solutions:

- Check whether the USB line is connected correctly, and the USB port is connected the PC.
- Check the USB driver is installed correctly.
- Check the USB port numbers on the device management, if it's more than 9, please change it within 3 – 9.
- The software output port need to be same with COM port.
- Insert a new and good port on the computer.
- Close the equipment power supply 3 minutes, than open again.
- Restart the computer, to ground the equipment and the computer.
- Replace a computer.

7.4 The Reading and Writing of U disk Question

Q: click the U disk file, show as "U disk is empty or error".

A: U disk error. Check the U disk port is correct. Replace a U disk.

Q: click the U disk file, show as "U disk reading...please wait", the indicator is off.

A: replace the U disk cable.